



SMART STREET

HV and LV Voltage and Configuration Optimisation Study

10 April 2018



VERSION HISTORY

Version	Date	Author	Status	Comments
First draft	4 April 2018	Geraldine Paterson	0.1	
Final	10 April 2018	Geraldine Paterson	1.0	

CONTENTS

1	INTRODUCTION	4
1.1	Purpose of document	4
1.2	What is Smart Street	4
1.3	Conservation voltage reduction (CVR)	4
1.4	LV network meshing	4
1.5	Application of Smart Street	4
1.6	Overview of the Smart Street test regimes	5
2	MODEL DEVELOPMENT	6
3	MODEL VALIDATION	7
4	DATA ANALYSIS	8
5	MODELLING SCENARIOS	9
6	RESULTS	10
7	CONCLUSIONS	16

1 INTRODUCTION

1.1 Purpose of document

The purpose of this document is to achieve the associated deliverable related to the Smart Street **SDRC 9.4.1 – Publish a final HV and LV Voltage and Configuration Optimisation report on the Smart Street website by April 2018.**

This document describes the methodology employed, simulation work carried out and analysis of trial data to quantify the effects of optimisation. The effects are quantified in terms of reduction of energy consumption and energy losses.

1.2 What is Smart Street?

Smart Street used advanced real time optimisation software to simultaneously manage high voltage (HV) and low voltage (LV) network assets to respond to customers' changing demands. Voltage management on HV networks reduced network losses while conservation voltage reduction (CVR) on the LV networks reduced energy demand. Capacitor banks on the HV network were used to help manage network losses by adjusting the network's power factor. On the LV network, a mix of capacitor banks and controlled meshing of networks were integrated to flatten the voltage profile and improve energy efficiency. The meshing of LV networks also released additional network capacity.

1.3 Conservation voltage reduction (CVR)

Electrical equipment made for the European market, including household appliances and lighting, is designed to operate most efficiently in the region of 220 to 230V. This equipment can, however, operate adequately at voltages in the region of 200V. If power is delivered at voltages higher than these optimum levels, energy will be consequently wasted. Excess voltage can shorten the useful life of electrical equipment, since the excess energy is dissipated as heat. Therefore optimising network voltages reduces overall energy consumption, improves power quality and extends the life of customers' equipment. Smart Street optimised network voltages by using CVR on the LV trial networks.

CVR on a distribution network is defined as a reduction of energy consumption resulting from a decrease in feeder voltage. Smart Street optimised the voltage by using on-load tap changing (OLTC) transformers. These transformers regulated the voltage along the feeder while maintaining statutory limits. This allowed for the peak load to be reduced, hence reducing the annual energy consumption.

Additionally Smart Street used shunt capacitors on the LV feeders to provide a voltage boost at the end of the circuit to reduce voltage drop. This flattened the voltage profile, allowing for the OLTC to tap closer to the lower limit.

1.4 LV network meshing

In addition to the proposed CVR techniques, Smart Street assessed the benefits of meshing LV networks to balance load while releasing network capacity at times of high demand.

Our project partner, Kelvatek, developed new controllable retrofit vacuum switching devices specifically for this project. These devices were used at the existing distribution boards and in link boxes across the LV trial circuits. The devices were remotely controlled allowing both sensing of feeder flows and reconfiguration of the LV network.

1.5 Application of Smart Street

Figure 1.1 shows an example of how the various Smart Street technologies were installed across the trial networks. The software included the ability to optimise for violations, losses

and to minimise load as a single Volt Var Compensation (VVC) function. The opportunity to mesh the trial networks was included in this function, but radial configurations were the preferred running arrangement. This was to minimise customer outages during electrical faults. Therefore the switching equipment was only closed (create loop or mesh networks) when the objective-function resulted in a positive change to the network above a set threshold.

The software calculated the best solutions to reach the optimisation objectives, which may be different for HV and LV depending on the chosen function. The user selected whether switching equipment should be included or inhibited in the optimisation scheme.

Figure 1.1: Smart Street network management

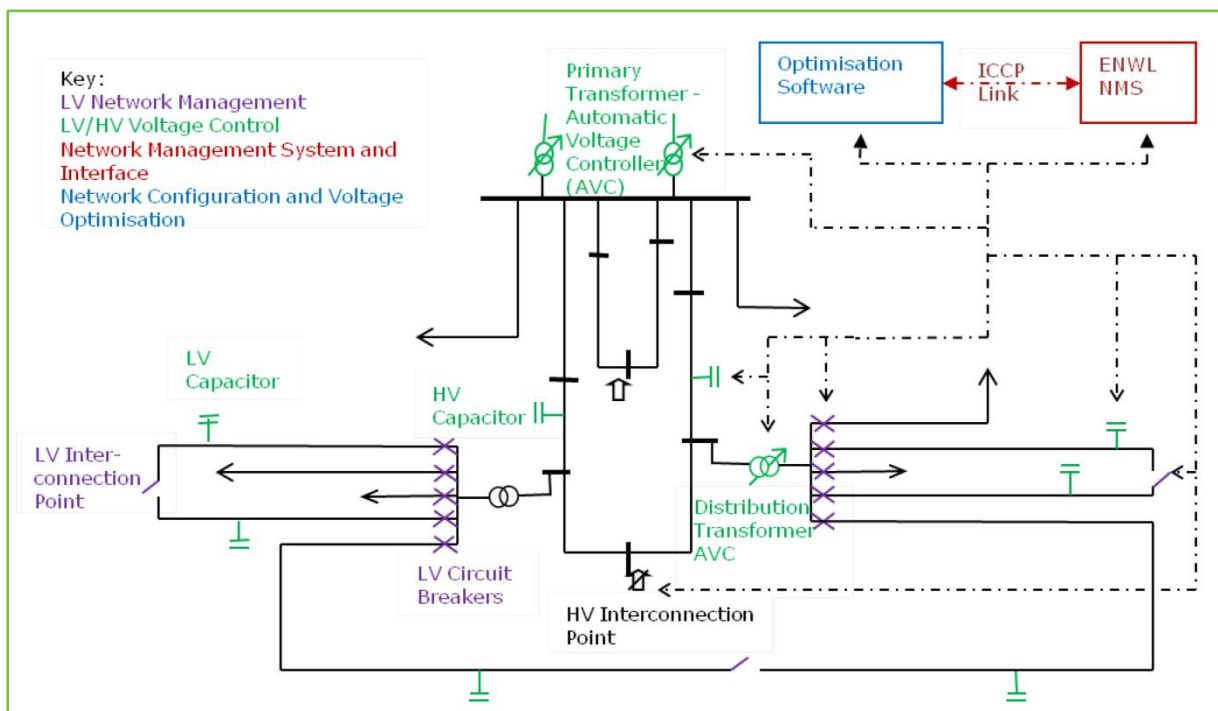

1.6 Overview of the Smart Street test regimes

A summary of the Smart Street trials is shown in Figure 1.2 below.

Figure 1.2: List of Smart Street trials

Smart Street Trial	Test regime
Trial 1: LV voltage control	T1.1 On-load tap changing distribution transformer only
	T1.2 On-load tap changing distribution transformer and capacitor(s) on LV circuits
	T1.3 Capacitors at distribution substation only
	T1.4 Capacitors at distribution substation and on LV circuits
	T1.5 Capacitor(s) on LV circuits only
Trial 2: LV network management & interconnection	T2.1 LV radial circuits
	T2.2 LV interconnected circuits
Trial 3: HV voltage control	T3.1 Voltage controllers at primary substation only
	T3.2 Voltage controllers at primary substation and capacitors on HV circuits
Trial 4: HV network management & interconnection	T4.1 HV radial circuits
	T4.2 HV interconnected circuits
Trial 5: Network configuration & voltage optimisation	T5.1 Losses reduction
	T5.2 Energy consumption reduction

The Smart Street trials were conducted over a two-year period providing sufficient data to compare normal network running configurations and Smart Street operational conditions, to calculate the overall benefits of optimisation.

2 MODEL DEVELOPMENT

The network data for the trial areas was extracted from the Electricity North West Control Room Management System and Geographical Information System and presented to our academic partners, in extensible markup language (XML). These files contained connectivity and technical data such as ratings, impedances, line lengths, etc. From this data the university converted the relevant data from these files to a readable OpenDSS format. OpenDSS was the software selected to model the networks as it allowed representation of unbalanced three phase plus neutral and time-series power flows. Following the input into OpenDSS a series of checks were carried out to ensure that all the data was correct and complete.

The Smart Street assets were added to the model as well as the relevant one-minute resolution load profiles of the connected customers. The load profiles were created using the ELEXON profile classes and a modified version of the CREST tool.

3 MODEL VALIDATION

The validation method compared the monitoring data with the power flow results simulated in the OpenDSS. The flow chart of the overall validation model is shown in Figure 3.1.

Figure 3.1: Validation process

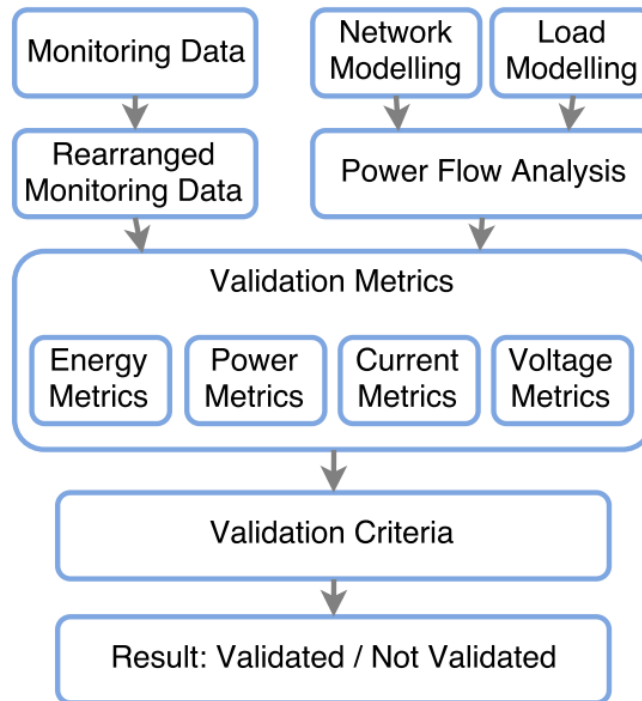

The validation metrics and criteria developed in the Electricity North West First Tier project Low Voltage Network Solutions were applied. This validation method compared percentage differences/errors between the monitoring data and the simulation data from the following aspects:

- Percentage error of energy consumption through the day
- Percentage error of energy consumption during peak time (5pm – 8pm)
- Mean percentage errors of single-phase current
- Mean percentage errors of single-phase voltage
- Percentage errors of three-phase active power.

The following four criteria were used to decide whether a feeder or network passed the validation:

- The model was valid if both energy metric errors were equal or smaller than 20%
- The model was invalid if one energy metric error was equal or greater than 70%
- The feeder/network was valid if the energy error metrics were between 20% and 70%, there were up to 30 customers, and the current and active power error metrics were similar
- The feeder/network was not valid if the energy error metrics were between 20% and 70%, there were more than 30 customers, and the current and active power error metrics were different.

This methodology highlighted some feeders which were not valid and subsequent investigation showed errors in the customer numbers and topology. Once these errors were corrected all feeders were deemed valid.

4 DATA ANALYSIS

The analysis of the data was based on a Monte Carlo approach, which caters for the stochastic nature of demand and generation and for tackling the unknown location of low carbon technologies (LCTs) in distribution networks. The Monte Carlo method can be defined as a computational algorithm that depends on repeated random sampling of unknown parameters to acquire numerical results. Monte Carlo methods are usually used in mathematical problems such as optimisation and the generation of draws from a probability distribution. It is very useful in situations where the application of a deterministic algorithm is not representative, such as in the case of unknown locations/sizes/behaviour of photovoltaic panels (PVs) or electric vehicles (EVs) on the network.

Two pools of 1,000 individual domestic profiles were randomly generated for the type of day to be assessed with their corresponding time-varying load models using the CREST tool. Non-domestic loads were represented by ELEXON profiles.

In order to model PV profiles, a set comprising the 30 sunniest irradiation curves of 2012 from the Whitworth Meteorological Observatory of The University of Manchester was considered. It was assumed that all systems would get the same irradiation as the length of the LV networks does not exceed 1km. Statistics from 2014 showed that the domestic scale PV panels currently installed in the UK have a distribution of 1%, 8%, 13%, 14%, 14%, 12% and 37% of 1.0, 1.5, 2.0, 2.5, 3.0, 3.5 and 4.0kW, respectively. This distribution of sizes was used for power flow simulations when allocating PV panels.

SSE's Second Tier Low Carbon Networks (LCN) Fund project 'My Electric Avenue' produced real data on EV charging. This data was coupled with statistical analysis on when cars are charged, how many cars are being charged, as well as the initial and final state of charge to give a range of profiles for this analysis. A representative pool of 1,000 EV profiles was generated using this methodology.

The Monte Carlo method was then applied to the 38 LV networks of Smart Street to assess the impact of LCTs and benefits of operational actions. The steps to carry out the Monte Carlo analysis are listed below and summarised in Figure 4.1:

1. The operational statuses of capacitors, switches and tap changers were set.
2. Random demand profiles were selected from the pool and allocated to each domestic customer respecting their profile class.
3. A random irradiance from the pool of 30 days was taken.
4. A percentage of the total customers were randomly assigned a PV panel. All the customers shared the same irradiance.
5. A percentage of the total customers were randomly assigned an EV profile.
6. A one-minute resolution time series power flow was performed using OpenDSS.
7. Impact metrics were calculated from power flow results.
8. When assessing the impact of an operational action (eg tap position for CVR) the process was repeated from step 2 to give the same initial conditions.
9. The process was repeated from step 1 a predefined number of times.

Figure 4.1: Flow chart for modelling process

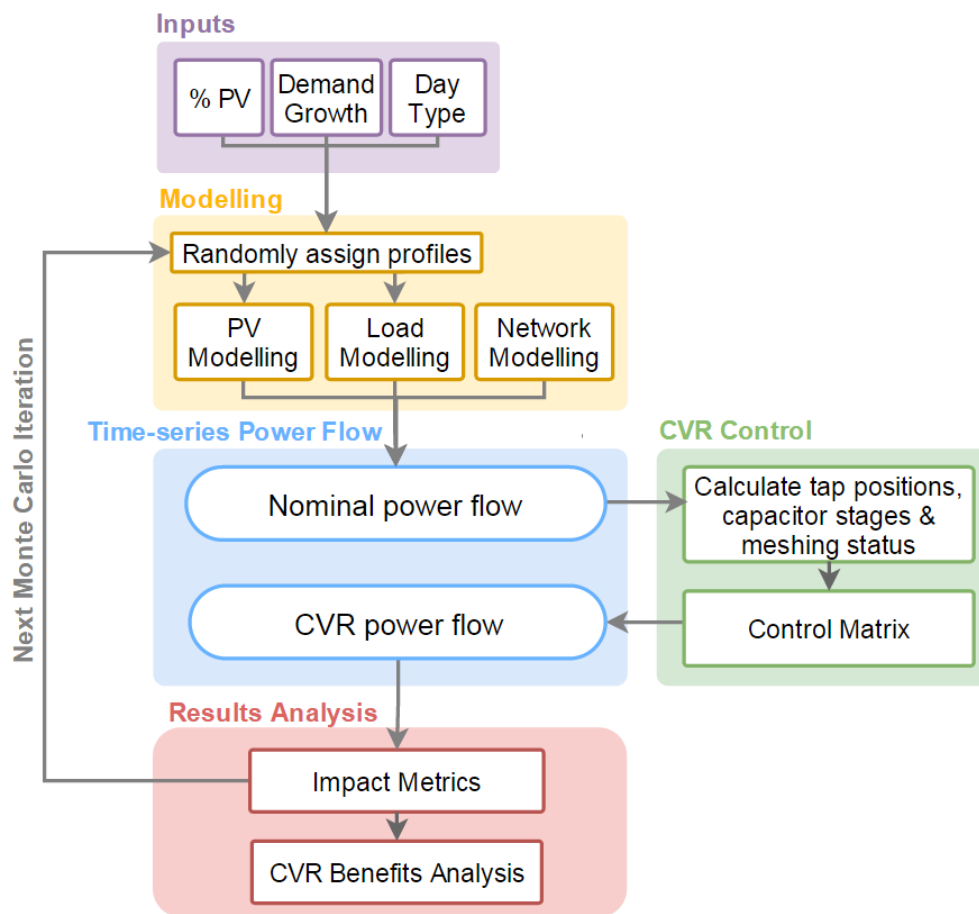

The metrics listed below were calculated after every Monte Carlo simulation. The median and standard deviation were obtained for each metric when all the simulations were complete. The latter contains the required information to conclude about any impact and benefit.

- Percentage of customers with voltage problems
- Utilisation factor of transformers
- Percentage of overloaded cables/lines
- Location of overloaded cables/lines
- Energy losses
- Total energy
- CVR factor

5 MODELLING SCENARIOS

As well as assessing the impact Smart Street has on today's network it was important to understand the benefits for future networks with different levels of demand and generation as well as the impact it has for different types of networks.

Our academic partners calculated the benefits of Smart Street for a range of scenarios which ensured all network types and demand variations were covered.

The criteria for the scenarios were:

- Three network types: rural, urban and dense urban
- Three optimisation modes: OLTCs, OLTCs and capacitors, OLTCs, capacitors and meshing
- Two day types: winter weekday and summer weekday
- Three different years: 2017, 2035 and 2050.

The combinations of all the above criteria resulted in 54 scenarios modelled and analysed.

In order to project the demand and generation growth for years 2035 and 2050 an average was taken of the four National Grid future energy scenarios which resulted in 20% and 40% PV penetration and multiplication factors of 1.0535 and 1.1859 for demand.

6 RESULTS

The analysis work was carried out by Queen’s University, Belfast and the University of Manchester using slightly different techniques but producing similar results. Figure 6.1 shows the high level results of the analysis.

These results highlight how the use of off-load tap changers can produce very different results. The first three columns show the benefit when the off-load tap changer settings remain unchanged. The second three columns show the increased benefit if the off-load tap changer settings are altered as the demand and generation changes. This alteration of settings could be done on a seasonal basis. This clearly demonstrates the benefits of optimising voltages on the LV network.

Figure 6.1 High level results

		Energy Consumption Reduction (%)						Losses Reduction (%)		
		Unoptimised NLTC			Optimised NLTC					
		2017	2035	2050	2017	2035	2050	2017	2035	2050
Dense Urban	Summer	2.9	3.4	3.7	6.4	6.9	7.2	8.1	10.3	7.0
	Winter	2.3	2.1	1.8	6.5	7.0	7.1	8.7	11.0	3.7
Urban	Summer	2.0	2.3	2.7	7.2	7.8	7.1	8.7	10.4	2.3
	Winter	1.3	1.1	1.0	7.8	8.5	8.1	9.8	12.2	7.1
Rural	Summer	2.3	2.4	2.9	6.4	7.0	7.0	10.8	11.6	5.0
	Winter	1.4	1.2	1.0	6.7	7.3	7.2	13.0	15.0	11.5

The scenarios detailed above allowed analysis of the different types of optimisation on the different networks out to 2050. This analysis will allow the solution deployed to be tailored to specific networks if required.

6.1 Energy consumption benefits

The charts below demonstrate the reduction in energy consumption achievable using the Smart Street method.

- Optimisation 1 is with only the primary and distribution on-load tap changers active
- Optimisation 2 is with the on-load tap changers and all capacitors active
- Optimisation 3 is with on-load tap changers, capacitors and interconnection active ie all devices.

Figure 6.2: Energy consumption reduction in 2017

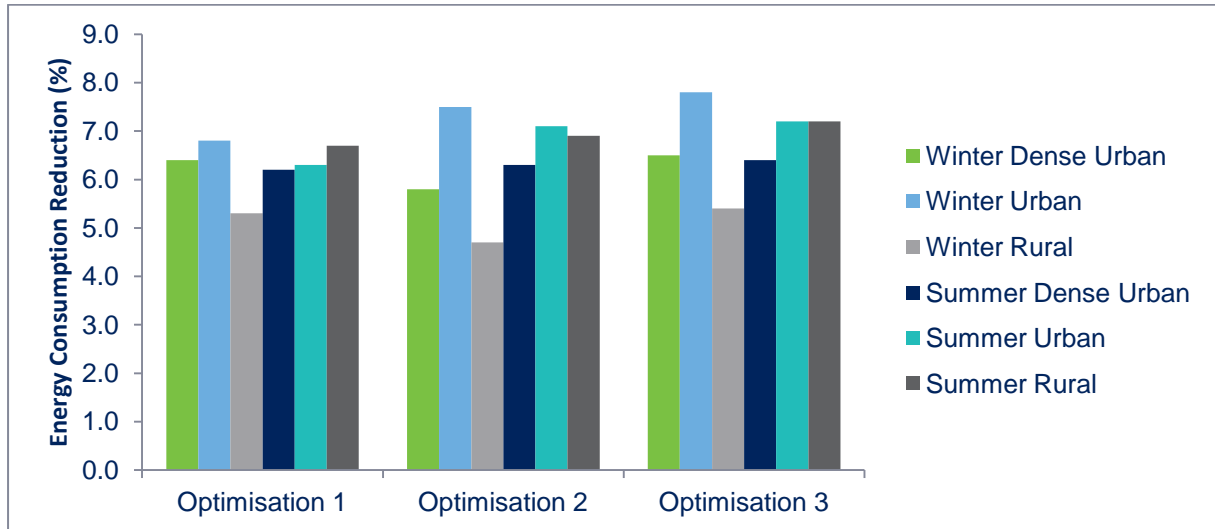

Figure 6.3: Energy consumption reduction in 2035

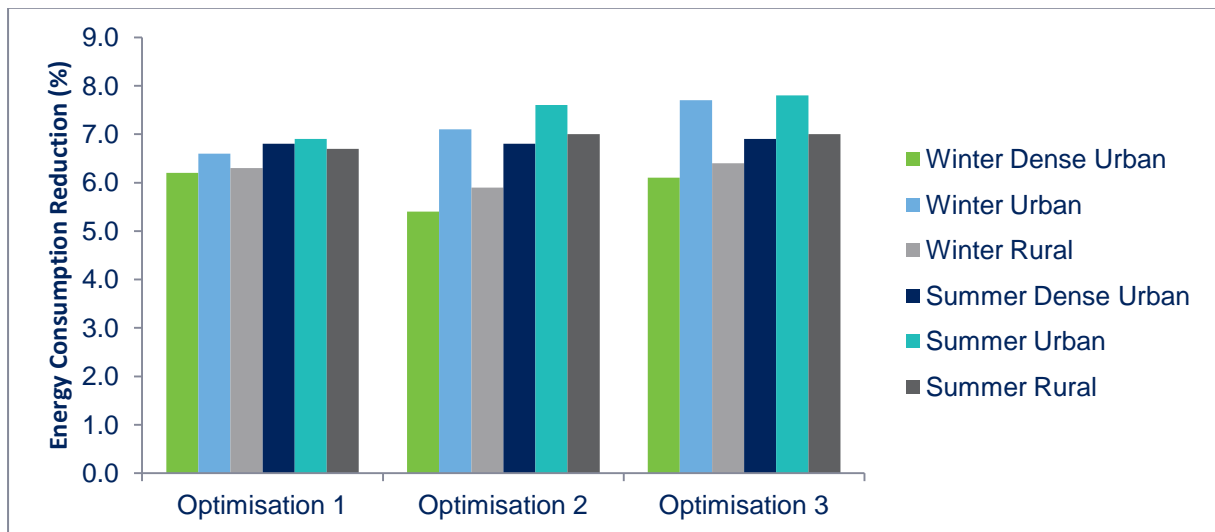
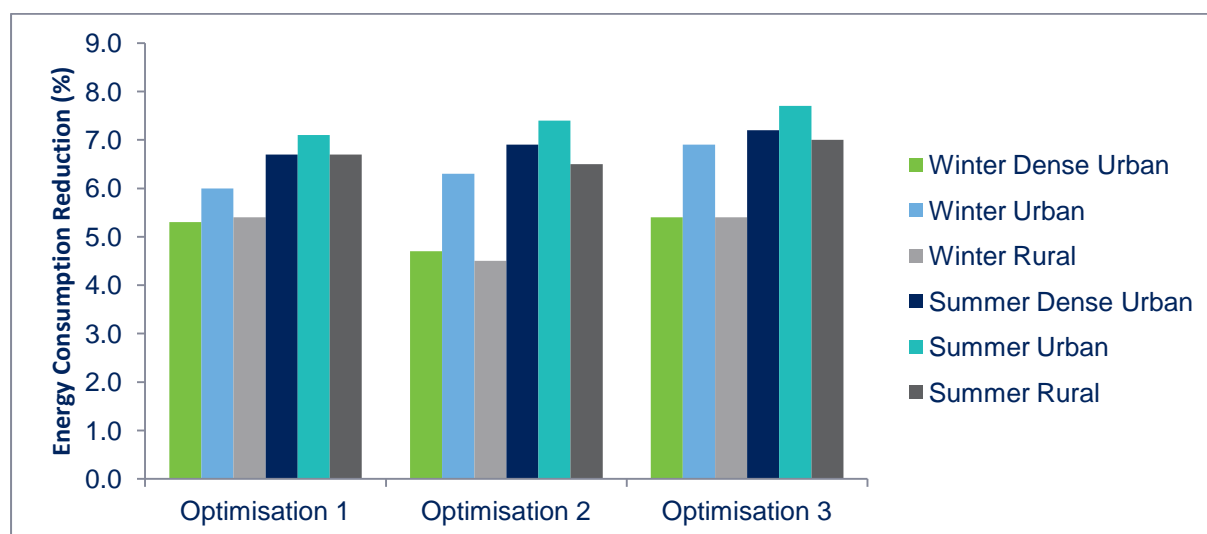

Figure 6.4: Energy consumption reduction in 2050



As can be seen from the charts Smart Street can deliver around 5 – 8% energy consumption reduction.

Larger voltage reductions are observed in the summer scenarios as:

- Energy consumption is less in summer than in winter, which results in a lower voltage drop giving more headroom for voltage reduction
- PV generation increases the feeder voltage, which provides more headroom for voltage reduction.

With the demand growth and PV growth in 2035 and 2050, the reduction of energy consumption is slightly increased in summer, but decreased in winter on all three networks.

Applying interconnection in optimisation 3 provided greater voltage reduction and therefore energy reduction.

The addition of capacitors gives more energy reduction in the summer scenarios but the largest influence on energy consumption reduction is the use of on-load tap changers.

The voltage at the primary substation was reduced by 1 – 4% by using the primary OLTC. Further voltage reduction was achieved by adding the LV off-load and on-load tap changers. This gave a total voltage reduction at the customer side of around 5 – 8% and overall energy reduction of 5 – 8%. This results in an average CVR factor roughly equal to 1, which means the relationship between voltage reduction and energy saving is roughly linear.

6.2 Losses benefits

The charts below demonstrate the reduction in losses achievable using the Smart Street method.

- Optimisation 1 is with the primary and distribution on-load tap changers active
- Optimisation 2 is with the on-load tap changers and all capacitors active
- Optimisation 3 is with on-load tap changers, capacitors and interconnection active ie all devices.

Figure 6.5: Losses reduction in 2017

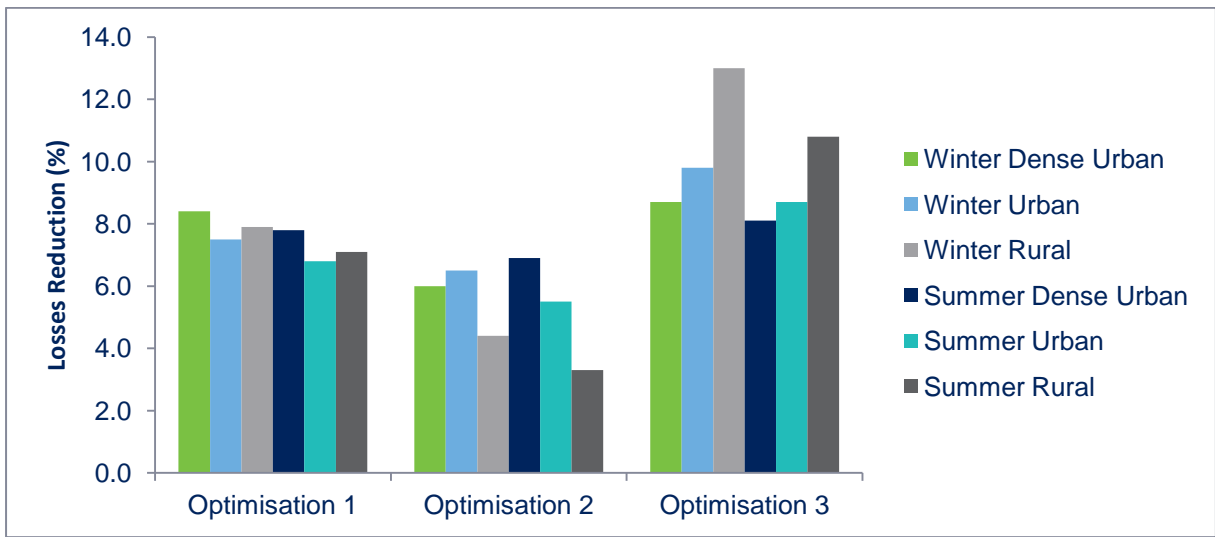

Figure 6.6: Losses reduction in 2035

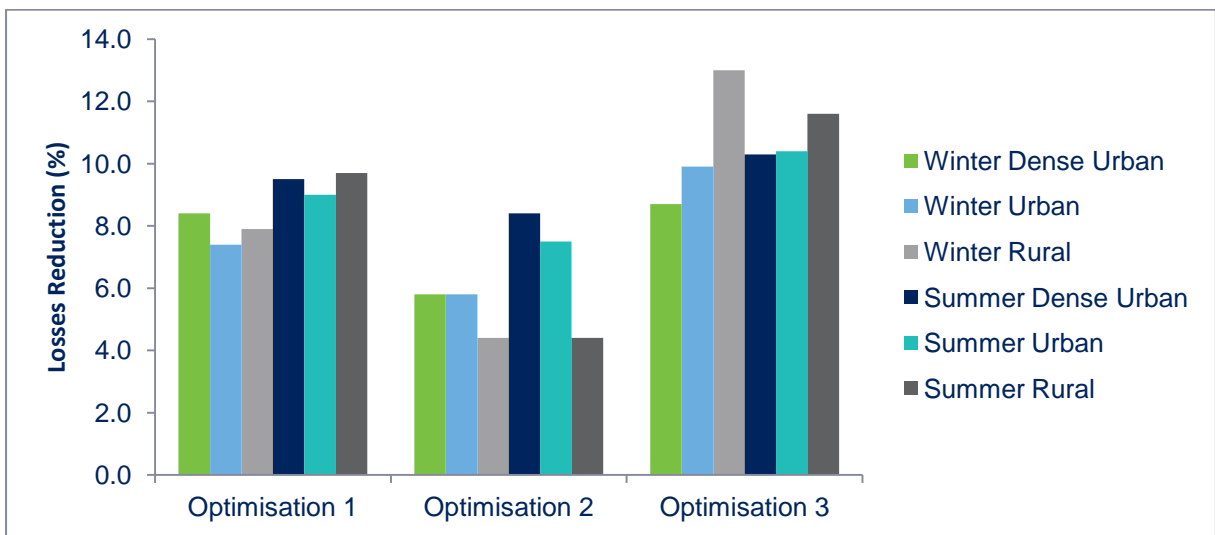
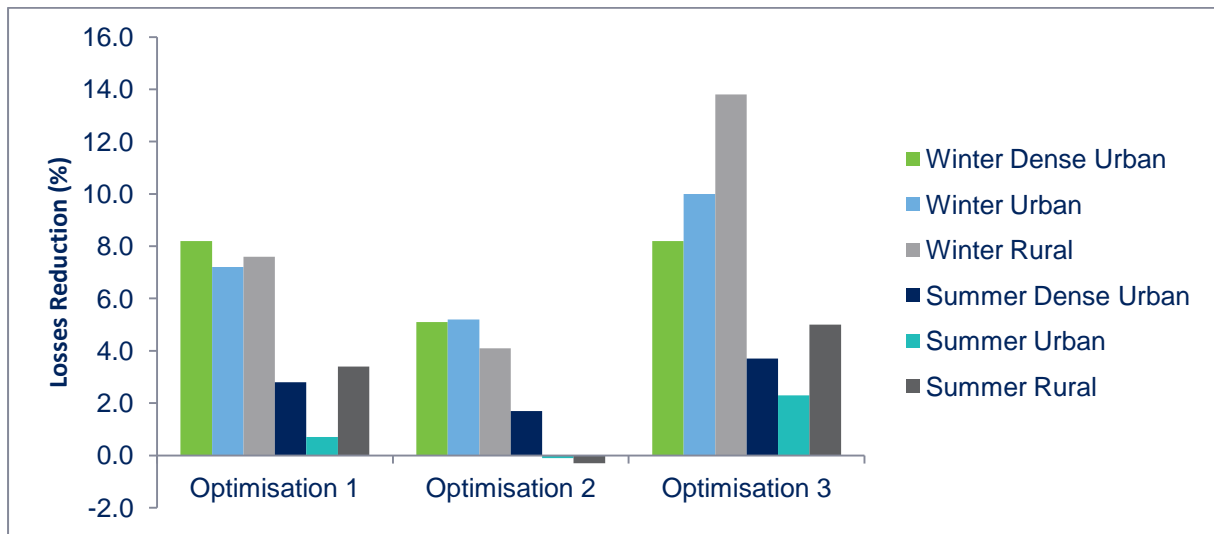

Figure 6.7: Losses reduction in 2050



The addition of capacitors to the voltage control has a negative effect on the loss reduction whereas interconnection gives a positive effect. Interconnection offers a similar benefit to losses to the use of the on-load tap changers but it does give more benefit on rural networks.

The effects increase with demand and generation growth until a ‘tipping point’ is reached due to the penetration of PV and subsequent reverse power flows; after this point the losses reduction reduces.

Optimisation 2 provides the lowest loss reduction as the reactive power provided by LV capacitors is too large when compared to the reactive power required by the network. In 2050 negative loss reductions are seen in summer scenarios for the urban and rural networks.

6.3 Trade-off between energy consumption versus losses

Figure 6.8 shows the trade-off between the two objective functions high voltage energy losses (HVL) and low voltage energy consumption (LVE) for a sample winter day at midday. The red dots are the complete set of feasible solutions generated by an exhaustive evaluation of device control setting combinations. The blue line with pentagram markers shows the Pareto front derived by applying a decomposition technique to this set of feasible solutions. The markers define the set of Pareto solutions.

Values on or close to the Pareto front can be considered as potential solutions to the optimisation problem. The choice between solutions depends on end-user priorities with regard to the different objectives. If the overall consideration is the total energy cost then this corresponds to applying an equal weighting to both objective functions with the optimum point highlighted as a green circle.

Comparing results, it can be seen that the LVE – HVL trade-off varies with the time of day/load on the network. However, the much larger scale and variation in LVE compared to HVL means that the minimum cost solution is dominated by minimisation of the LVE component.

Figure 6.8: Losses vs energy savings trade-off

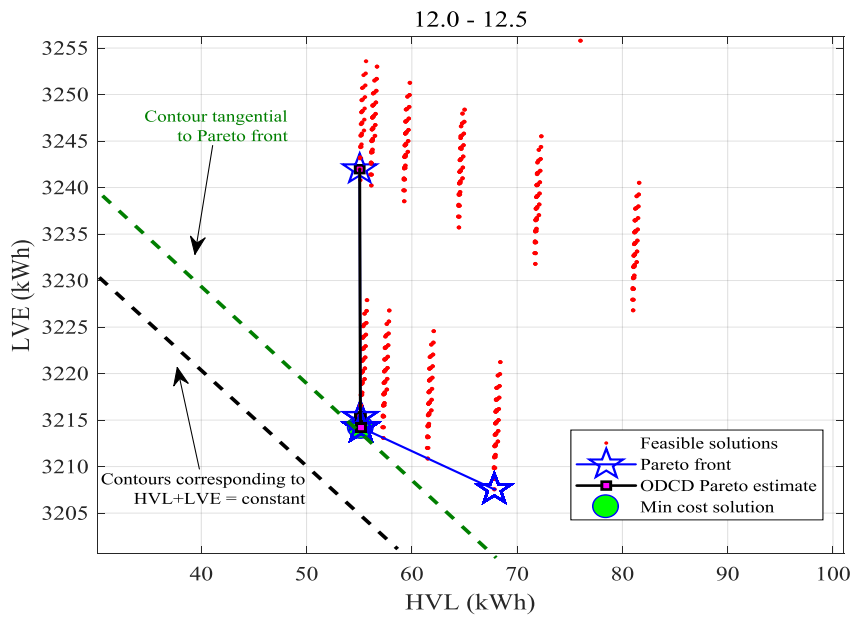

Figure 6.9 quantifies the actual and percentage reduction in HVL and LVE after optimisation in comparison with nominal operation for eight different load scenarios. As stated above, the reduction in HV energy loss is relatively small compared to the reduction in LV energy consumption.

The maximum LVE percentage reduction happens for the summer weekend scenario, although the actual energy reduction corresponding to this scenario is the lowest among the scenarios considered.

Figure 6.9: Losses vs energy savings for different scenarios

Load Profile	Reduction in LV Energy (%)	Reduction in LV Energy (MWh)	Reduction in HV Losses (%)	Reduction in HV Losses (MWh)
Autumn weekday	7.90	10.60	8.60	0.19
Autumn weekend	8.40	9.90	9.30	0.17
Spring weekday	8.10	10.40	8.60	0.17
Spring weekend	8.30	9.50	9.00	0.15
Summer weekday	8.10	9.50	8.10	0.13
Summer weekend	8.40	8.50	8.10	0.13
Winter weekday	8.10	12.60	8.50	0.24
Winter weekend	8.00	10.90	8.70	0.20

The analysis has shown that trade-off between energy consumption versus losses varies with the time of day and with the load on the network. However, the much larger scale of energy consumption reduction, compared to losses, means that the most effective solution is

dominated by energy consumption. As a consequence, it is better to optimise for energy consumption and this will still deliver a reduction in losses.

It should be noted that while the overall trade-off patterns are similar, there are some clear differences between the use of capacitors and tap changers with the different load scenarios. The HV capacitor and tap changers of the OLTC transformer combine in order to help flatten the voltage profile for each load scenario. When the HV capacitors contribute more to the system (especially in the summer load scenarios), lower tap positions are selected on the OLTC transformers and vice versa.

To further show the benefit of optimising off-load tap changers, additional analysis was conducted. If the off-load tap changers are not changed, the analysis showed fewer feasible solutions as there is less headroom for the primary transformer tap changers to be adjusted. In addition the magnitude of energy consumption and loss reduction is much less than when the off-load tap changers are optimised.

7 CONCLUSIONS

7.1 Voltage control

From the analysis carried out, optimised control of voltage setpoints for tap changers can offer significant benefits for energy consumption and losses. Optimising setpoints as demand and generation changes provides greater benefit than just applying global setpoints. Given the positive benefits that tap changers have proven to offer, Electricity North West has amended its distribution transformer specification to include them as an option.

The capacitors were selected based on analysis using Electricity North West's current planning policy. This policy assumed a global 7% voltage drop along the feeders which could be boosted by a capacitor. When the trials were conducted it was noticed that the voltage drop is almost negligible, which meant that the capacitors were rarely required to maintain the voltage. From the academic analysis it can be seen that capacitors can provide benefits for energy consumption but they have a negative effect on losses. It may be that future demand, generation and network topology means that a capacitor will offer benefits but based on these findings it is not currently Electricity North West's intention to deploy them at scale.

7.2 Interconnection

Interconnecting feeders brings benefits in terms of voltage regulation and the utilisation factor of the feeders. The equivalent impedance of the interconnected feeders is smaller than just the feeder with the largest impedance which results in smaller deviations from the LV busbar voltage.

There are only certain conditions in which the network and customers would benefit from being interconnected to improve the voltage and feeder utilisation. At other times, keeping the interconnection point closed would subject more customers to interruptions in the event of a fault. Therefore using the optimisation routine to only close the interconnection point when required offers benefits to both customers and the network operator.