

Delta Energy & Environment Ltd
Registered in Scotland: No SC259964
Registered Office: Floor F, Argyle House, 3 Lady Lawson Street, Edinburgh, EH3 9DR



Managing the future network impact of electrification of heat

FINAL report for ENWL

June 2016

Contact:

stephen.harkin@delta-ee.com, +44 131 625 1005

jon.slowe@delta-ee.com, +44 131 625 1004



Copyright © 2016 Delta Energy & Environment Ltd. All rights reserved.

No part of this publication may be reproduced, stored in a retrieval system or transmitted in any form or by any means electronic, mechanical, photocopying, recording or otherwise without the prior written permission of Delta Energy & Environment Ltd.

Unless otherwise credited all diagrams in this report belong to Delta Energy & Environment Ltd.

Disclaimer

While Delta Energy & Environment Ltd ('Delta-ee') considers that the information and opinions given in this work are sound, all parties must rely upon their own skill and judgement when making use of it. Delta-ee does not make any representation or warranty, expressed or implied, as to the accuracy or completeness of the information contained in the report and assumes no responsibility for the accuracy or completeness of such information. Delta-ee will not assume any liability to anyone for any loss or damage arising out of the provision of this report.

The report contains projections that are based on assumptions that are subject to uncertainties and contingencies. Because of the subjective judgements and inherent uncertainties of projections, and because events frequently do not occur as expected, there can be no assurance that the projections contained herein will be realised and actual events may be different from projected results. Hence the projections supplied are not to be regarded as firm predictions of the future, but rather as illustrations of what might happen. Parties are advised to base their actions on an awareness of the range of such projections, and to note that the range necessarily broadens in the latter years of the projections.

Executive Summary	4
Introduction & project scope	12
Overview of different heat pump technologies	14
▶ High level description of the different types of heat pump technologies	
▶ Technology costs, performance & 'fit' into different house types – current & future	
▶ Summary of housing stock in ENWL's region & defining the 6 heat pump – house type combinations	
High level overall methodology	22
Heat pump load profile outputs	24
▶ Methodology for developing granular & robust heat pump load profiles	
▶ Review of existing studies & projects measuring heat pump load profiles	
▶ Temperature profiles considered in this analysis & selection of outputs from our building physics modelling	
▶ Results from developing load profiles for different heat pumps in different house types	
Diversifying heat pump load profiles & clustering of heat pumps	32
▶ Overview of approach	
▶ Outputs of diversification of heat pump load profiles	
▶ Clustering assumptions for allocating different heat pump types to different LV feeder types	
Forecasting heat pump uptake rates and low-voltage distribution network impacts	44
▶ Developing the three scenarios for heat pump uptake on ENWL's network	
▶ Impact of heat pump uptake on ENWL's low-voltage distribution network – network interventions & cost of upgrading the network	
Optimisation of heat pump load profiles	69
▶ Overview of optimisation approach	
▶ Flexibility of HP operation	
▶ Outputs from Imperial's optimisation modelling – optimised load profiles	
▶ Impact of the optimised profiles on ENWL's network	
Customer side measure analysis	80
▶ Description of customer side measures & approach for assessing these measures	
▶ Analysis & quantification of reduction in the impact implementation of these measures have on ENWL's network	
Recommendations	111
Annexes	113

Executive summary (1/7)

Key messages

1. Electrification of heat using heat pumps will **increase winter electricity demand by around 2.5 kW – 5.5 kW per household**. For this project, a building physics model was used to generate half-hourly load profiles for different types of heat pumps in different house types at different outside temperatures.

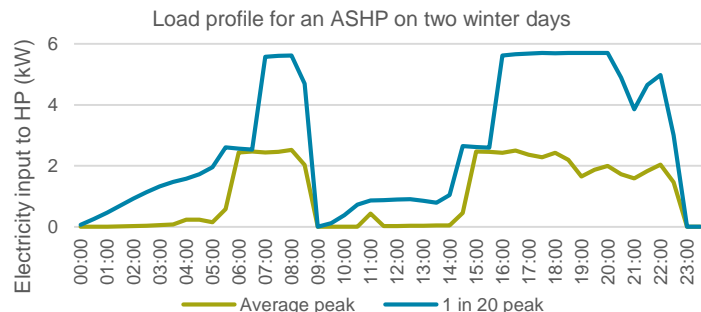

2. Granular analysis of the types of heat pumps likely in Electricity North West's region suggests **additional peak loads of ~250 MW up to 3.5 GW by 2050**. If a significant proportion of heat demand is met by electricity, it will become important to plan network capacity for a '1 in 20' winter peak* (as currently done by gas), instead of for an 'average' winter peak (as is currently the case for electricity distribution). Diversity amongst heat pump operation will be low: based on a limited available evidence base, we estimate only 10-15% diversity in an 'average' winter peak, lower in a '1 in 20' winter.

Scenario	Share of homes with a heat pump	Additional network load on an 'average' winter peak	Additional network load on a '1 in 20' winter peak
Low	~5%	200 – 300 MW	400 – 500 MW
Reference	~20%	800 – 900 MW	1,400 – 1,500 MW
High	~50%	~2,500 MW	~3,500 MW

3. 'National' electricity system players may influence heat pump load profiles, so their operation depends on short-term electricity price. Imperial College modelled the national system, including analysis of potential flexibility of heat pump operation. This showed at times of low electricity prices, **flexibility could increase peak loads by 5 – 15% on 'average' peak winter days, and as high as ~25% on a '1 in 20' peak winter day**.

4. Using the detailed heat pump load profiles and scenario uptakes, EA Technology's Transform Model** forecasts **£150 million to £3.3 billion of required investment** in capacity on the Electricity North West LV network across our three scenarios, if the network is planned for a '1 in 20' winter peak. This corresponds to an additional 2,000 – 21,500 network interventions by 2050.

Network investment of £100s millions to £ billions by 2050

5. Electricity North West is unlikely to have much control over the uptake of heat pumps and their operation, but a number of customer-side measures could reduce the increases in peak load from the electrification of heat. **These could significantly reduce the additional network investment requirements**, but may be very expensive to introduce. For example, under the high scenario, improving the insulation levels of all dwellings installing a heat pump could reduce network investment costs to 2050 by ~£600 million (costing around £570 million to implement).
6. Policy / regulations may result in some of these measures being introduced without Electricity North West's intervention, and for others, **additional value (e.g. via demand response) could be captured by other energy system stakeholders so some of the costs of introducing these measures could be shared**. A full cost benefit analysis will be required to account for implementation costs.
7. The analysis in this report shows that **there may be tensions between customer-side measures which support the national generation and distribution system, and those that support the local distribution network**. It will therefore be **important that decisions consider both scales of network**, and that the wider economic impact is assessed.

* Outside temperatures are typically well below zero degrees C, all day, during a '1 in 20' winter peak day

** See Annex C of this report for a brief description of the Transform Model

Executive summary (2/7)

Electrification of heat could increase peak load on ENWL's network by 3.5 GW

Heat pump uptake in ENWL's region by 2050 could add 0.25 – 3.5 GW of new load at peak times

- ▶ Electrification of heat is a key pillar of the UK's strategy for decarbonising residential heating – with heat pumps being a key solution for delivering this.
- ▶ Three different uptake scenarios for heat pumps have been assessed, ranging from a low scenario (where around 6% of all homes in ENWL's region will have a heat pump by 2050) to a high scenario (where 50% of all homes will have a heat pump by 2050).
- ▶ Based on the forecasted uptake of different types of heat pumps in ENWL's region, the additional load from all heat pumps on ENWL's network in 2050 will peak at 0.25 GW – 3.5 GW (depending on the outside temperature, the mix of heat pumps being installed and the heat pump uptake rate).

Load profile* for an ASHP in a semi-detached dwelling

Load profile for a HT ASHP in a semi on an 'average' peak winter day

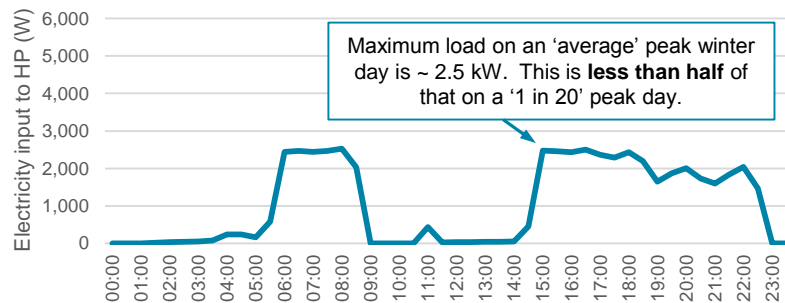

Load profile for a HT ASHP in a semi on a '1 in 20' peak winter day

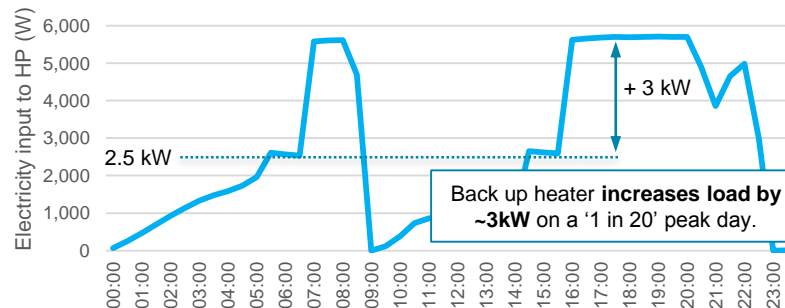

At the household level, heat pumps can increase load by 2.5 – 5.5 kW

- ▶ On an 'average' peak winter day, the heat pump part of an ASHP meets all the heating needs of a dwelling and adds up to 2.5 kW of load per dwelling.
- ▶ Due to colder temperatures on a '1 in 20' peak winter day, the heat pump part of an ASHP is supplemented by a back up electric heater. This results in a much higher load of up to 5.5 kW per dwelling. Assuming an existing peak load of 1.5 kW per house, ASHPs will increase demand at peak times by ~2 – 4 times.
- ▶ This load increase from ASHPs varies depending on the house type considered, and varies more significantly in dwellings with a hybrid heat pump (as discussed on the next slide).

Overall impact of heat pump uptake on additional electricity load on ENWL's network by 2050

	Low scenario	Reference scenario	High scenario
'Average' peak	+0.25 GW	+0.85 GW	+2.5 GW
'1 in 20' peak	+0.45 GW	+1.5 GW	+3.5 GW

* The heat pump load profiles illustrated on this slide, and throughout the report, are for a week day.

HT ASHP = Higher temperature ASHP

Executive summary (3/7)

Heat pump load profiles will vary widely across the network

Understanding the uncertainty & variations in heat pump load profiles will be important for ENWL when preparing its network

- ▶ The additional peak load heat pumps add per dwelling varies significantly depending on: the house type the heat pump is installed in; the type of heat pump installed; the control strategy of the heat pump; and the outside air temperature (as illustrated below).
- ▶ On 'average' peak winter days, the maximum load from ASHPs in semi detached dwellings ranges from ~1.8kW in a new build dwelling to ~2.5kW in an older dwelling. This load more than doubles on '1 in 20' peak days. Hybrid heat pumps offer the potential to reduce load on '1 in 20' peak days through switching to 'boiler only' mode (using gas for heating, rather than electricity). This however requires controls in hybrids to be configured to enable this, and price signals to be provided to drive this mode of operation.
- ▶ Depending on the uptake of these different heat pumps & the clustering of uptake on certain areas of ENWL's network, understanding these variations will be critical for influencing heat pump operation & managing investments in its network.

Load profiles for different heat pump-house types on an 'average' peak winter day

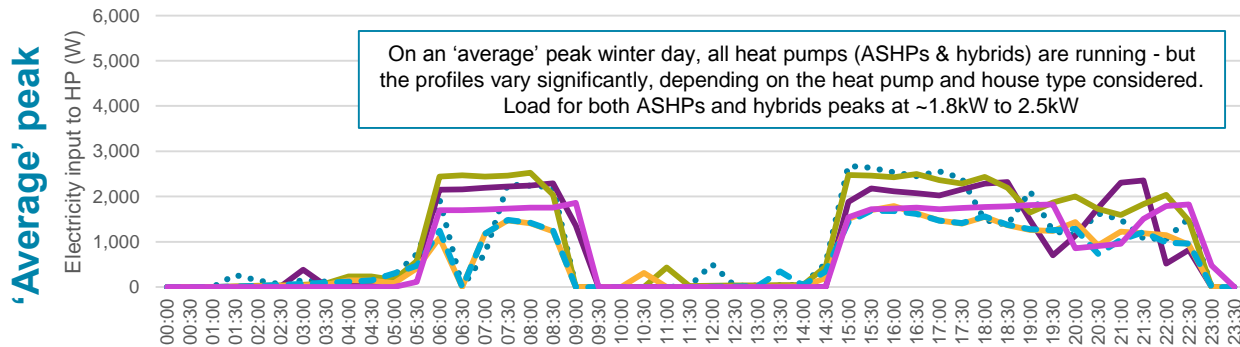

Load profiles for different heat pump-house types on a '1 in 20' peak winter day

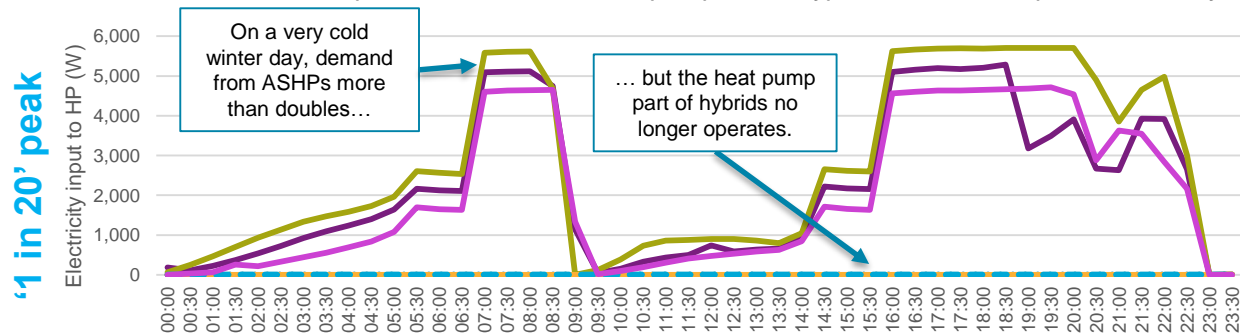

There is not one standard heat pump load profile

- ▶ For this study, we developed load profiles for 6 combinations of different types of heat pumps in different types of dwellings.
- ▶ As illustrated on the left, on an 'average' peak winter day, these profiles vary significantly in terms of the maximum electricity demand and the timing of the peak demand.
- ▶ This variation is even more significant on a '1 in 20' peak winter day.

- Hybrid HP in detached
- LT ASHP in semi
- HT ASHP in semi
- Hybrid HP in semi
- - - Hybrid HP in terrace
- LT ASHP in new build

Executive summary (4/7)

Diversification is unlikely to provide much mitigation to peak load increases

Diversification will reduce loads slightly, but unlikely to provide much mitigation

- ▶ Existing electricity demands (of household appliances) are highly diversified, due to a wide range of loads being incurred by different customers with different demand profiles. But for heating, there is much less diversity in operation of heating systems and the timing of when heat is needed.
- ▶ Diversification of operation of a single type of ASHP at the LV feeder level ('DNO level'), on an 'average' peak winter day, results in a small reduction in peak load of about 10 - 15%, with peak load falling from 2.3kW to 2kW. Across the six heat pump – house types considered in this study, diversification of heat pump operation reduces peak demand (per household) from ~1.8 – 2.5 kW to 1.5 kW - 2.3 kW on an average winter day.
- ▶ This will result potentially result in additional peak load from heat pumps falling by 10 – 15% on an 'average' peak day due to the diversified operation of heat pumps. This reduction is even lower on a '1 in 20' peak winter day, when outside temperatures are lower and households are likely to be running their heating systems for longer.

Undiversified vs diversified (@ DNO level) load profiles for a LT ASHP in a semi on an 'average' peak winter day

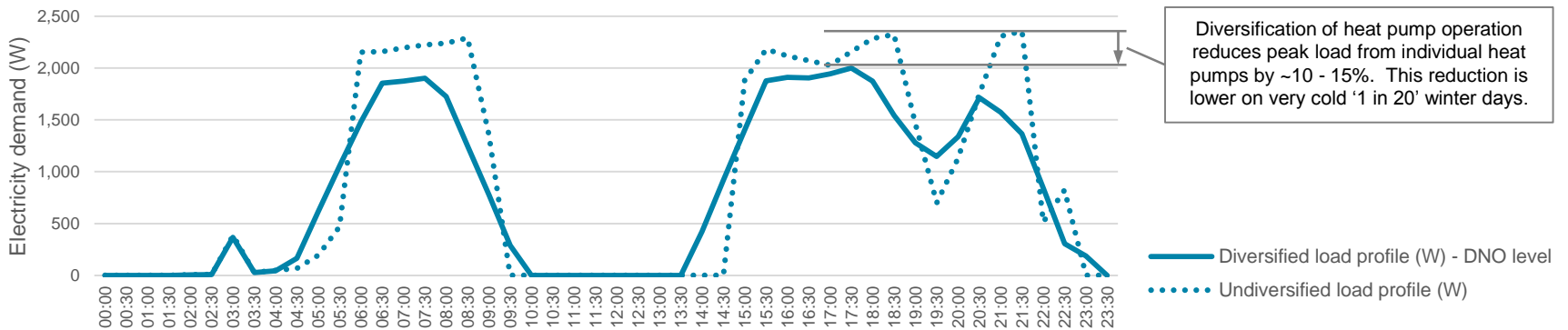

Diversified load profiles for the different heat pump house types on an 'average' peak winter day

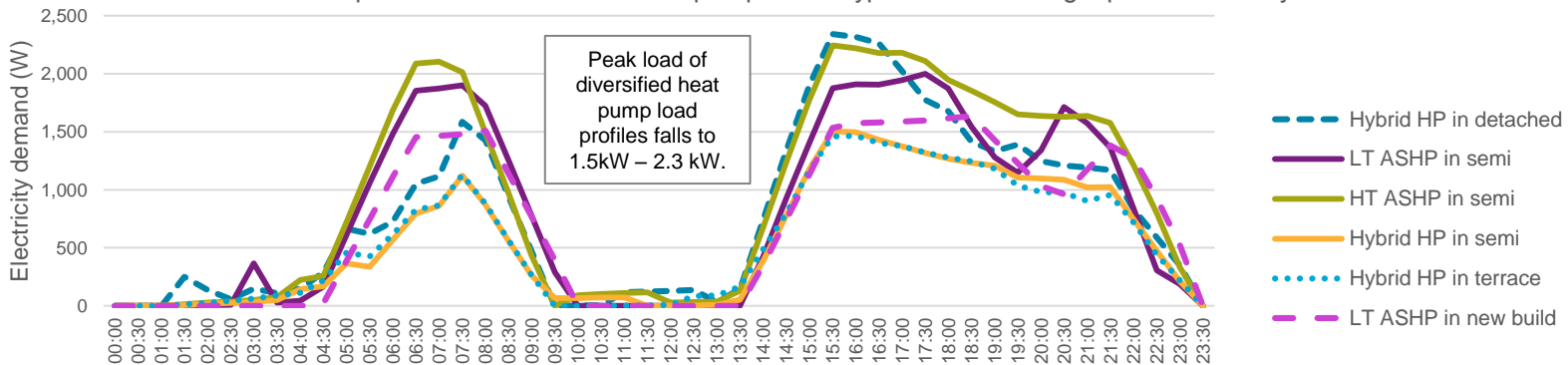

Executive summary (5/7)

The impact on network reinforcement could be £100 millions to £ billions by 2050

Increases in peak load will require significant network reinforcement

- Based on the new heat pump load profiles developed, and using different uptake rates for heat pumps to 2050 in EA Technology's Transform v5.0 model, LV network reinforcement costs by 2050 are estimated at between £150million (under the low scenario) to £3.3 billion (under the high scenario), if ENWL plans its network for a '1 in 20' winter peak. The reference scenario investment costs, assuming around 20% of homes in 2050 have a heat pump, is around £340 million.
- These costs are incurred by varying numbers and types of network interventions being required under the different scenarios. Around 2,000 interventions are required by 2050 under the low scenario, growing to 21,500 under the high scenario (which also assumes high uptake rates for other low carbon technologies). The reference scenario estimate is around 4,000 interventions (which also assumes modest uptake rates for others low carbon technologies).
Based on ENWL's current allowance of 200 interventions per year, the high scenario represents up to 3 times the current average annual interventions.
- In the low scenario, most investment is required in the 2040s, but in the reference and high scenarios, significant investment starts in the 2020s (during RIIO ED2). Across all three scenarios, most interventions and investment is required on LV infrastructure in suburban streets.

Cumulative number of interventions over time for each scenario – '1 in 20' winter

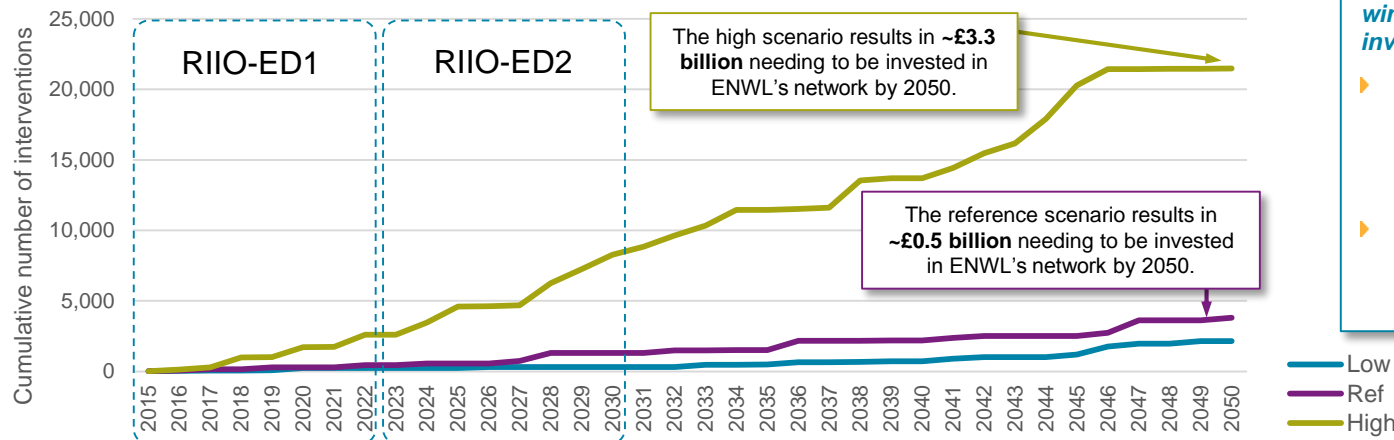

Planning for an 'average' winter peak reduces network investment costs slightly

- This slide illustrates the costs and volume of interventions required by 2050 if ENWL plans its network for a '1 in 20' (or extreme) winter peak.
- If ENWL plans the network for an 'average' peak, investment costs by 2050 range from ~£25 million up to £2.6 billion.

Intervention required if network is planned for a '1 in 20' winter peak

	Low	Reference	High
Cumulative number of network 'interventions' by 2050 per scenario	2,145	3,808	21,482
LV transformer upgrades (ground mounted & pole mounted)	1,346	1,754	6,607
LV underground works (major & minor)	799	2,054	14,865
Other	0	0	10
Total investment required for upgrading the LV network (£)	150 million	340 million	3.3 billion

Executive summary (6/7)

Impact on the network may be increased if heat pump operation is 'optimised'

Influencing heat pump operation to maximise consumption of low cost renewable electricity could worsen network impacts for DNOs

- ▶ Installation of thermal storage & improved insulation of dwellings could allow heat pump operation to be shifted to earlier or later in the day. If this flexibility in heat pump operation is used to maximise consumption of lower cost renewable electricity, we could see even more heat pump load being shifted to peak times, if this coincides with a spike in renewable output.
- ▶ On 'average' peak winter days, 'optimisation' of heat pump load profiles by Imperial College suggests that load from ASHPs could be increased at peak times by up to ~1 kW, and for hybrid heat pumps by up to 2 kW. This increases overall heat pump load on the network at peak times **by 5 – 15%**. On '1 in 20' peak winter days, we see no increase in the load of ASHPs at peak times, but load from hybrids at peak times can increase by 3kW, which increases overall heat pump load on the network at peak times **by ~25%**.
- ▶ Under our reference scenario for heat pump uptake, 'optimisation' of heat pump load profiles increases the **number of network interventions required by 2050 by ~25 – 70%, and the associated investment costs increase by ~£100 - 200 million**. For an 'average' peak day, we see ~70% more interventions being required with investment costs increasing by £190 million, while on the '1 in 20' peak day the number of interventions increase by 24%, with costs increasing by ~£110 million.

Un-optimised & optimised load profile for HT ASHP in semi on an 'average' winter day

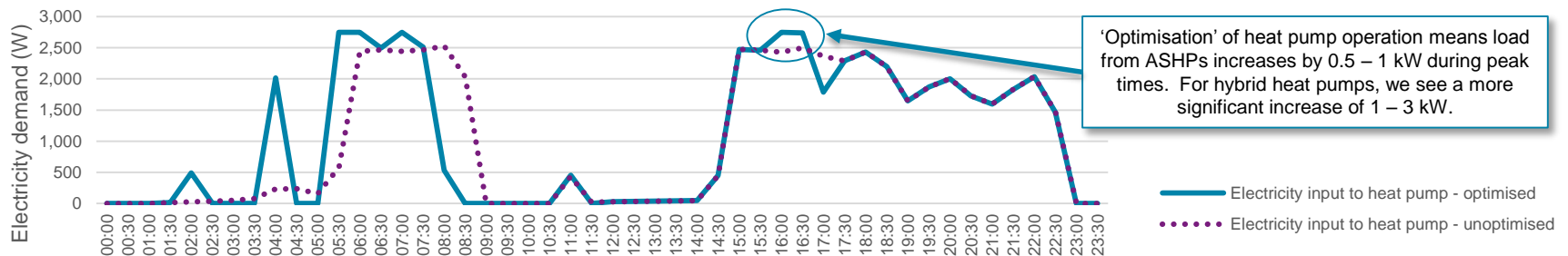

Cumulative number of network interventions required under the reference scenario (for a '1 in 20' peak winter day) with un-optimised & optimised heat pump load profiles

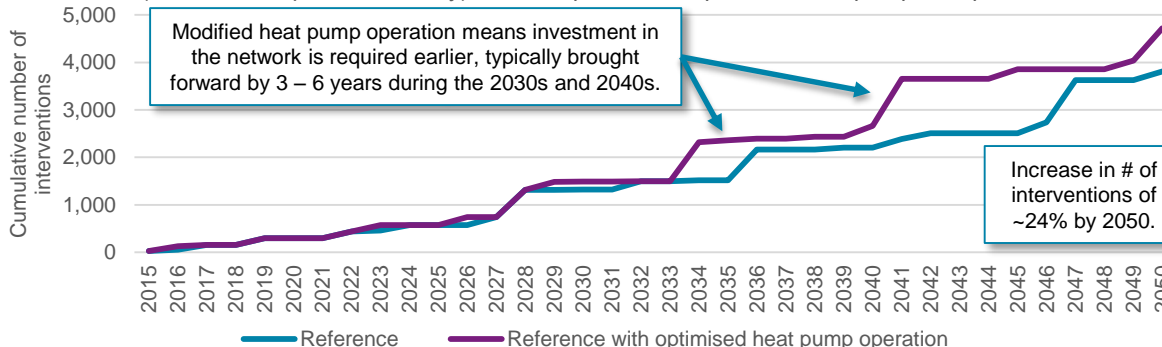

Impact of 'optimised' heat pump operation on ENWL's network during a '1 in 20' winter peak

Overall increase in number of interventions by 2050:

24 %

Overall impact on investment required by 2050:

£ 110 million

Executive summary (7/7)

Customer side measures could reduce network reinforcement costs by up to 95%

Whilst DNOs do not have control over heat pump uptake, DNOs may be able to take customer orientated measures to mitigate the impact of peak loads

- ▶ ENWL could work with customers to reduce peak loads from heating through measures such as reducing heating demands with efficiency improvements, incentivising installation of more efficient heat pumps, or different control and storage strategies, or using distribution pricing structures to limit adverse impacts from other parties (such as suppliers).
- ▶ There are also wider measures outside of heating which could be used including the appropriate use of distributed generation, electric vehicle storage, reductions in demand across other electricity uses, demands side response across other electricity uses, and use of community energy schemes.
- ▶ The avoided costs of these measures (aimed at heating only) for the reference scenario could be up to £200 – 300 million. Under the high scenario, the avoided costs could be more than £3 billion by 2050.
- ▶ There will be additional costs for the implementation of the measures which could exceed the intervention savings. Some of these may be borne by ENWL where measures are directly implemented by ENWL, as part of other support mechanisms such as national programmes. It will be important for ENWL to coordinate activities with any external programmes to ensure there are no unintended consequences.

Avoided network interventions costs (£ millions) by 2050 from implementing different customer side measures under the high scenario, if ENWL plans its network for a '1 in 20' winter peak.

Customer side measures applied under the high scenario	2022	2030	2050
	<i>Avoided network investment costs by 2050 (£ millions)</i>		
Customer measure A1: increasing the level of insulation of all dwellings	95	302	595
Customer measure B1: installing higher capacity heat pumps (only for LT & HT ASHP)	175	301	2,358
Customer measure B3: installing higher efficiency heat pumps (for all HP house types)	98	285	-72
Customer measure C1: incentivise hybrid uptake rather than ASHP uptake	285	940	3,148
Customer measure C2: micro CHP installed alongside heat pumps	95	294	379
Customer measure D1: shifting HP operation with control strategies	285	940	3,170
Customer measure D2: battery storage installed alongside heat pumps	285	940	3,170

Executive Summary	4
Introduction & project scope	12
Overview of different heat pump technologies	14
▶ High level description of the different types of heat pump technologies	
▶ Technology costs, performance & 'fit' into different house types – current & future	
▶ Summary of housing stock in ENWL's region & defining the 6 heat pump – house type combinations	
High level overall methodology	22
Heat pump load profile outputs	24
▶ Methodology for developing granular & robust heat pump load profiles	
▶ Review of existing studies & projects measuring heat pump load profiles	
▶ Temperature profiles considered in this analysis & selection of outputs from our building physics modelling	
▶ Results from developing load profiles for different heat pumps in different house types	
Diversifying heat pump load profiles & clustering of heat pumps	32
▶ Overview of approach	
▶ Outputs of diversification of heat pump load profiles	
▶ Clustering assumptions for allocating different heat pump types to different LV feeder types	
Forecasting heat pump uptake rates and low-voltage distribution network impacts	44
▶ Developing the three scenarios for heat pump uptake on ENWL's network	
▶ Impact of heat pump uptake on ENWL's low-voltage distribution network – network interventions & cost of upgrading the network	
Optimisation of heat pump load profiles	69
▶ Overview of optimisation approach	
▶ Flexibility of HP operation	
▶ Outputs from Imperial's optimisation modelling – optimised load profiles	
▶ Impact of the optimised profiles on ENWL's network	
Customer side measure analysis	80
▶ Description of customer side measures & approach for assessing these measures	
▶ Analysis & quantification of reduction in the impact implementation of these measures have on ENWL's network	
Recommendations	111
Annexes	113

Problem statement

1. Increasing deployment of residential electric heating will require ENWL to invest in strengthening its network. Electrification of heat could lead to very large changes (of 'orders of magnitude') in demand on ENWL's network (particularly during peaks) compared to other changes. ENWL investments to reinforce the network could be very high. By taking a much more granular view than ENWL has done to date, it is possible to determine a far deeper and more robust view on how much investment, when, and what the sensitivity is to different electrification scenarios.
2. Other players in the electricity value chain (electricity suppliers and the system operator) will influence the operation of electric heating (likely willing to pay substantially more for this influence than DNOs) – based on national, not local, price signals. If these players influence operation against the interests of ENWL, this could make the challenge for ENWL even greater. Delta-ee will assess what impact this will have on the above investment requirements.
3. Given (1) and (2), what are the range of options for ENWL to mitigate network reinforcement through interventions on the customer side of the meter or other commercial arrangements? For example, would incentivising thermal stores or insulation be more cost effective than network reinforcement? Could commercial arrangements be established that limit the ability to shift demand in the 'wrong' direction during ENWL constraints? How do these options compare, and what are the preferred options for ENWL to further explore and perhaps demonstrate?

Key project objectives

1. Determine scenarios for likely uptake of different types of electric heating in different types of houses in ENWL region (2022 / 2030 / 2050), and assess degree of clustering by LV feeder and by LV substation. The focus of this will be domestic properties. For non-domestic impacts the current Transform assumptions will be used. These assumptions will however be reviewed by Delta-ee.
2. Develop load profiles for different types of domestic electric heating in different house types – and assess likely co-incidence factors in their operation to develop aggregate load profiles at the LV feeder.
3. Assess the impact of electrification of domestic heat on ENWL's network to identify constraints.
4. Determine ability to shift time of electricity demand for different types of heat pumps in different house types.
5. Model price signals from other value electricity value chain players to shift time of electricity demand in 2022 and 2030, with high level view to 2050, and therefore determine modified load profiles as a result of this.
6. Assess the impact of electrification (with these modified load profiles) of heat on ENWL's network to identify constraints.
7. Identify, assess, and prioritise range of options for ENWL to intervene on the demand side (or through other commercial arrangements) to mitigate the impact of electrification on their networks taking into account the interests of other players in the electricity value chain.

Executive Summary	4
Introduction & project scope	12
Overview of different heat pump technologies	14
▶ High level description of the different types of heat pump technologies	
▶ Technology costs, performance & 'fit' into different house types – current & future	
▶ Summary of housing stock in ENWL's region & defining the 6 heat pump – house type combinations	
High level overall methodology	22
Heat pump load profile outputs	24
▶ Methodology for developing granular & robust heat pump load profiles	
▶ Review of existing studies & projects measuring heat pump load profiles	
▶ Temperature profiles considered in this analysis & selection of outputs from our building physics modelling	
▶ Results from developing load profiles for different heat pumps in different house types	
Diversifying heat pump load profiles & clustering of heat pumps	32
▶ Overview of approach	
▶ Outputs of diversification of heat pump load profiles	
▶ Clustering assumptions for allocating different heat pump types to different LV feeder types	
Forecasting heat pump uptake rates and low-voltage distribution network impacts	44
▶ Developing the three scenarios for heat pump uptake on ENWL's network	
▶ Impact of heat pump uptake on ENWL's low-voltage distribution network – network interventions & cost of upgrading the network	
Optimisation of heat pump load profiles	69
▶ Overview of optimisation approach	
▶ Flexibility of HP operation	
▶ Outputs from Imperial's optimisation modelling – optimised load profiles	
▶ Impact of the optimised profiles on ENWL's network	
Customer side measure analysis	80
▶ Description of customer side measures & approach for assessing these measures	
▶ Analysis & quantification of reduction in the impact implementation of these measures have on ENWL's network	
Recommendations	111
Annexes	113

High level description of the different heat pumps considered in this study

Heat pumps (HP) use physical principles in order to move (or “pump”) energy from a place with a lower temperature level, e.g. from the outside air, to somewhere with a higher temperature level, e.g. the flow temperature required in a heating system. The types of heat pumps which have been considered in this study are summarised below.

Type of heat pump	Description
Air-source heat pump, low temperature	<ul style="list-style-type: none"> ▶ An air-source heat pump uses electricity and energy from the outside air in order to supply heat to a building. ▶ The seasonal conversion efficiency of electricity to useful heat is around 250-300% in the UK, as the heat pump extracts 1.5 - 2 units of energy from the outside air for every unit of electricity it consumes. ▶ This is subject to seasonal changes, as the outside temperature affects the heat pump’s ability to extract energy. The higher the outside temperature, the more energy the heat pump can extract per unit of electricity it consumes. Daily efficiencies will therefore vary. ▶ A low temperature heat pump as defined in this project reaches flow temperatures of 55°C (this is the temperature of the water leaving the heat pump, which feeds the space heating & hot water circuits). The key element for the heat pump’s efficiency is the difference between the heat source (in this case the outside air) and the flow temperature it has to achieve. Buildings requiring lower flow temperatures (for example: well insulated buildings & new builds) will therefore achieve higher seasonal conversion efficiencies.
Air-source HP, high temperature	<ul style="list-style-type: none"> ▶ High temperature air-source heat pumps have the same key functionalities as low temperature versions. ▶ The main difference to a low-temperature air-source heat pump is that high temperature heat pumps can achieve higher flow temperatures of up to 80°C and are optimised to doing so. ▶ Their seasonal efficiencies (if required to run at these high temperatures) will nevertheless be lower than those of low temperature systems.
Hybrid air-source heat pump	<ul style="list-style-type: none"> ▶ Hybrid air-source heat pumps are a combination of a low temperature air source heat pump with a fossil fuel boiler (gas or oil), which is controlled by a single, intelligent controller. ▶ The main advantage of hybrid heat pumps is that the controller allows the heating system to switch between fuel sources (i.e. to use the boiler, or the heat pump, or both parts) based on the efficiency of the system under current circumstances (e.g. outdoor temperature, flow temperature, etc.). This can be combined with other information, such as energy prices or noise level, to optimise the operation of the system as a whole. ▶ In general this will mean that the boiler will take over from the heat pump during very cold periods (when the efficiency of the heat pump part falls).
Ground source heat pump	<ul style="list-style-type: none"> ▶ Similar to air-source heat pumps, ground source heat pumps use electricity to make renewable energy, in this case from the ground, using either vertical boreholes or a horizontal collector. ▶ From a depth of 10-15 meters the temperature of the ground is stable at around 10°C throughout the year. Due to this higher and more stable source temperature, a ground-source heat pumps are more efficient than air source heat pumps. ▶ Ground source heat pumps are, due to the high costs linked to developing the ground source, more expensive than air source heat pumps

Suitability of different types of heat pumps to different house types

Depending on the type of heat pump system considered, not all homes will be suitable for installation. For example, air source heat pumps will require suitable outside space for an outdoor unit, while ground source heat pumps will require outside space for drilling a hole for vertical ground loop or a large space for laying a horizontal ground loop. In most case, space for a hot water storage tank will be required internally.

In the below table, we map on to certain house types the heat pump technologies are most likely to be suitable for that dwelling type.

The factors considered that influence the suitability of different types of heat pumps for different house types:

- ▶ Available **space inside** the dwelling for hot water tanks & internal units.
- ▶ Available **space outside** the dwelling for external units or for ground loops.
- ▶ Availability of **gas connection** – a gas connection is required for hybrid heat pumps with a gas boiler to be deployed.
- ▶ The **density of housing**. Rural vs urban locations can be used as a proxy for the density of housing.

Summary of the types of dwellings where different heat pumps will best fit

	Detached	Semi-detached / end terrace	Mid terrace	Flat
Urban, On gas	ASHP Hybrid (with a large capacity HP) GSHP	ASHP Hybrid (with a small capacity HP)	Possibly ASHP Hybrid (with a small capacity HP)	None
Urban, Off gas	ASHP GSHP	ASHP	Possibly ASHP	None
Rural, On gas	ASHP Hybrid (with a large capacity HP) GSHP	ASHP Hybrid (with a small capacity HP) Possibly GSHP	Possibly ASHP Hybrid (with a small capacity HP)	None
Rural, Off gas	ASHP GSHP	ASHP Possibly GSHP	Possibly ASHP	None

Choice of higher temperature versus lower temperature ASHP

Depending on the age of the dwelling and the type of heat distribution system installed in the dwelling, a higher temperature or a lower temperature ASHP will be more appropriate for installation.

COP vs SCOP vs SPF – How a heat pump’s efficiency is measured

Three different types of measure are used to discuss and compare heat pump (HP) efficiencies:

- COP:** Coefficients Of Performance are measured steady state efficiency values. To obtain them HPs are tested in accredited test laboratories against the requirements of a measurement standard. As the tests only provide rated efficiencies of a product at a set of pre-defined, steady state temperature levels, only the technical efficiency of different HPs can be compared. Other factors, like e.g. the control strategy, are not taken into account by these measurements.

The COP describes the ratio between heat output and energy input of an electrically driven heat pump at specific temperature levels. A COP of three for example means that for each unit of electricity which the HP consumes it provides 3 units of heat to the building, by “pumping” two units of energy from the lower to the higher temperature level.
- SCOP:** The Seasonal COP is a calculated seasonal efficiency of a HP. It is obtained by using the COPs obtained in the laboratory tests to calculate the seasonal efficiency of a HP in different climate zones. As both the calculation and the test methodologies are standardised, these values can be used to compare the technical efficiency of different heat pumps.
- SPF:** The Seasonal Performance Factor is a field-measured seasonal efficiency value. This measure implicitly takes into account all factors which influence a HPs efficiency (see next page), but it is also this reason that makes it difficult to use this measure to compare individual HP installations.*

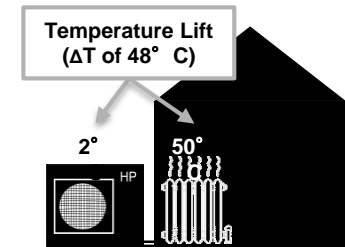

What affects the efficiency of an air-source heat pump installation?

The efficiency data used in this report is based on averaged COP data from a number of HP models from companies selling in the UK, as depicted on the right. This graph shows a strong correlation between the outdoor temperature and the COP of a HP.

Indeed, the main variable that affects the efficiency of an air-source HP is the level of difference between the lower (outdoor) and higher (heating system) temperature level (ΔT , or temperature lift) as shown in the top right. The higher the temperature lift, the lower the efficiency of the HP.

The temperature lift is dependent on the variation in outdoor temperature through the year, and on the variation in flow temperature that is required to heat a building. As the outdoor temperature cannot be influenced, the flow temperature is therefore the main vector to improve a HP’s performance. We have therefore modelled different buildings which use higher or lower flow temperatures, in order to reflect the high variance in installations that can be expected in the field.

Many other variables, like the control strategy of the HP, the building suitability and sizing of the system, the user behaviour or the commissioning of the installation influence a HPs efficiency, mainly through affecting the temperature lift. These are discussed in more detail on the following page.

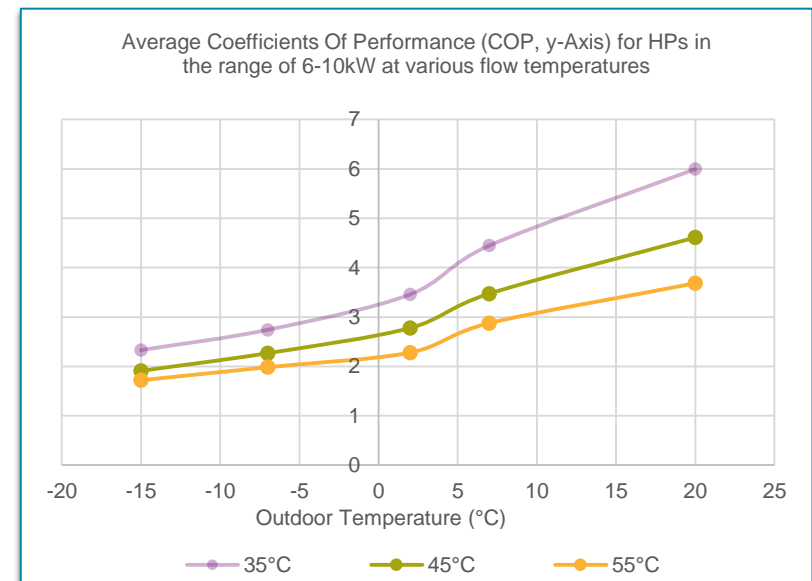

*Anecdotal evidence from a long-running HP field-trial in Switzerland for example suggests variations of up to 30% in similar buildings, equipped with the same HP model, purely related to user behaviour. Similar impacts of user behaviour have been found in the EST field trial in the UK.

What affects the efficiency of an air-source heat pump installation? (continued)

There are various factors that can influence the efficiency of an air-source heat pump (ASHP) installation, mostly by affecting the flow temperature that the system requires at a given temperature, but also through an increased need for cycling the installation for example (switching the HP on and off). These can be grouped into three overarching categories:



Technical efficiency and control strategy:

As with all products, there are more and less performant heat pumps. Based on a comparison of the current toprunner product with the averaged performance values over a range of products, an increase in technical efficiency of at least 15-20% seems technically feasible, but currently only at the expense of higher product costs. The control strategy can help to reduce the temperature lift, by foreseeing weather compensation, as well as through reducing the need for cycling the HP.

Building Suitability:

The suitability of a building for a HP installation is probably the single most important factor influencing the temperature lift and therefore the performance of the HP on the coldest day of the year. Houses heated with radiators require higher flow temperatures than houses heated through underfloor heating, as the surface area of the heat emitters is lower. At a given heat emitter surface area, more insulation also allows for a lower flow temperatures, as less heat needs to be transferred into the building at peak times. Heat Pumps therefore perform and “fit” best in well-insulated buildings with underfloor heating (very low flow temperatures), and poorest in non-insulated buildings with radiators (very high flow temperatures).

Sizing and Design:

The sizing of the HP and the design of the installation can be an important influence of the overall performance of the system. HPs which are designed too small for their building will on the one hand need to run on higher temperatures to meet the building’s heat demand, and they will on the other hand rely more on the direct-electric back-up heater in order to heat the building.

Commissioning:

The proper commissioning of the HP is another very important factor for the HPs efficiency. Optimising the heating curve, DHW temperature and legionella prevention cycles for the needs of the building and user can be crucial for the performance of the system.

Temperature Settings and DHW Use:

The user behaviour can influence the HP performance. Higher room temperatures e.g. require higher flow temperatures to reach them.

Due to the many parameters which can influence the performance of a HP in a building, we have modelled six different combinations of buildings and heat pumps to generate a variety of load profiles for heat pumps in ENWL’s distribution area. These combinations are summarised on slide xx.

Typical fully installed costs for different types of heat pumps

Costs for Heat Pumps are currently much higher than those for a standard boiler

Due to a much smaller market (heat pumps only account for approximately 1% of the UK's heating system market) and an underdeveloped supply chain, heat pumps are currently significantly more expensive than a gas boiler, which is the current default solution in most UK homes.

Based on research for our Pathways[®] Tool, an adjusted version of which has been used to forecast the uptake of heat pumps in ENWL's distribution area under different scenarios for this project, the typical fully installed costs for different types of heat pumps are summarised in the table on the right. These are the values that have been used to forecast heat pump uptake in ENWL's region.

Research carried out by Delta-ee for DECC suggests that the fully installed costs of a heat pump break down into: roughly 60% of the total cost is for the equipment; and 40% is non-equipment costs (including overheads, installation, margin etc. – see figure below). The cost reduction potential for ASHP installations based on a mass market scenario (at least 20% penetration in the heating market) suggests that costs could be reduced by at least 20% in the future. This is reflected in our forecasted view of the fully installed cost by 2050.

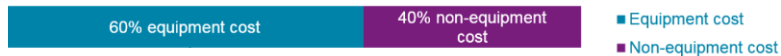

Break-down of the fully installed costs for an ASHP (40kW, but similar break-down for smaller systems)

Source: Delta-ee for DECC

Data from Delta-ee's Pathways 2.0 model

Heat pump type	Fully installed cost (£) in 2015	Fully installed cost (£) in 2050
ASHP higher temperature	9,000	5,200
ASHP lower temperature	6,100	3,500
GSHP Borehole	14,333	11,500
GSHP Trench	12,833	10,000
Hybrid heat pump (with a higher capacity ASHP)	8,200	5,500
Hybrid heat pump (with a lower capacity ASHP)	5,900	3,800

Comment on exclusion of ground source heat pumps from analysis in this study

Delta-ee has excluded ground source heat pumps for the modelling and analysis in this study for a number of reasons:

1. The very high fully installed costs of GSHPs (summarised above) mean uptake will be very low compared to other heat pump types
2. GSHP uptake will largely be limited to large detached dwellings – due to space constraints – which form only a small share of dwellings in ENWL's region.

Summary of housing stock in ENWL's region

The housing stock in ENWL's region (the 'North West') is dominated by semi detached and terraced dwellings.

- ▶ A breakdown of the dwelling stock in the North West of England is illustrated below. This is taken from the NEED database.
- ▶ **Semi-detached/end terrace** and **mid terraced** dwellings will be the most important building types to consider when modelling heat pump uptake in ENWL's region, as these house type account for almost three quarters of dwellings in ENWL's region.
- ▶ Detached dwellings also represent a modest share of the dwelling stock – where heat pumps will have a 'good fit' and therefore will also be considered.

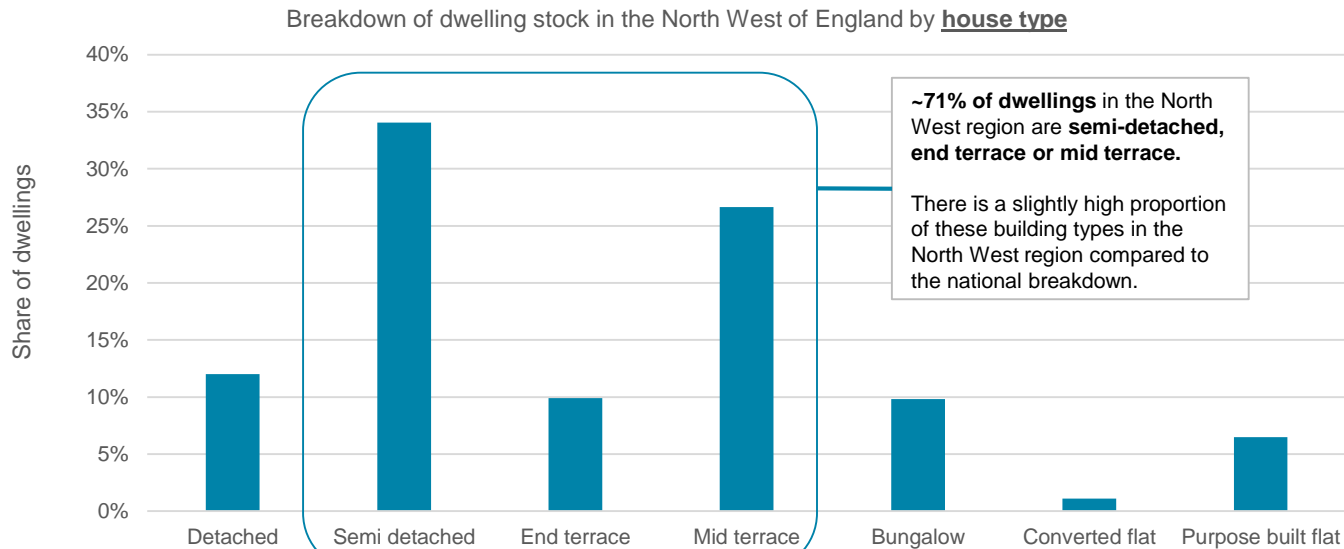

Total of **2.2 million dwellings** on ENWL's network



The six heat pump – house type combinations considered in this study

On the previous slides, we have summarised the main types of electric heat pumps currently available in the UK, the suitability of these heat pumps for installation in different types of dwellings, the typical fully installed costs of these heat pumps, and breakdown of the dwelling stock in ENWL's regions.

This has resulted in Delta-ee arriving at **six** combinations of a certain heat pump in a certain house type ('heat pump – house types') that will most likely see significant uptake in ENWL's region in the future. These are the six core heat pump house types that we have considered in the study and for which we have developed granular load profiles.

The six heat pump – house type considered in this study are:

1. Semi-detached dwelling with a hybrid heat pump (gas boiler with a low capacity ASHP)
2. Semi-detached dwelling with a lower temperature ASHP
3. Semi-detached dwelling with a higher temperature ASHP
4. Terrace dwelling with a hybrid heat pump (gas boiler with a low capacity ASHP)
5. Detached dwelling with a hybrid heat pump (gas boiler with a high capacity ASHP)
6. New build semi detached dwelling with a lower temperature ASHP

Load profiles will be developed for the following heat pumps in the indicated house types:

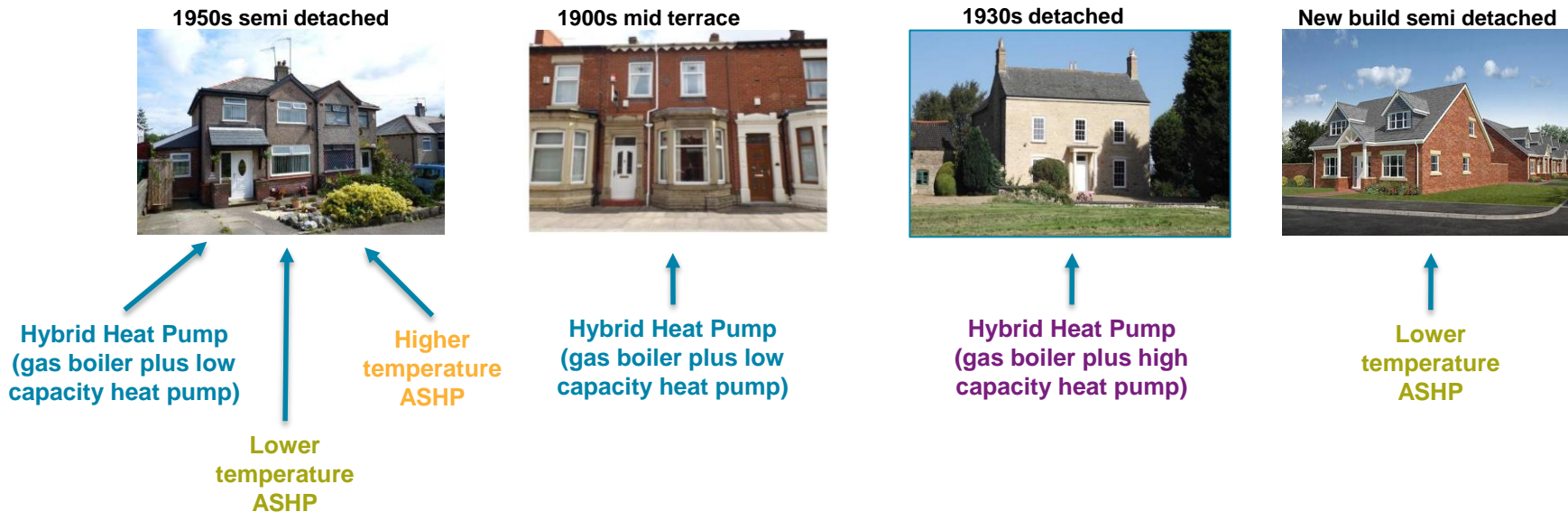

Executive Summary	4
Introduction & project scope	12
Overview of different heat pump technologies	14
▶ High level description of the different types of heat pump technologies	
▶ Technology costs, performance & 'fit' into different house types – current & future	
▶ Summary of housing stock in ENWL's region & defining the 6 heat pump – house type combinations	
High level overall methodology	22
Heat pump load profile outputs	24
▶ Methodology for developing granular & robust heat pump load profiles	
▶ Review of existing studies & projects measuring heat pump load profiles	
▶ Temperature profiles considered in this analysis & selection of outputs from our building physics modelling	
▶ Results from developing load profiles for different heat pumps in different house types	
Diversifying heat pump load profiles & clustering of heat pumps	32
▶ Overview of approach	
▶ Outputs of diversification of heat pump load profiles	
▶ Clustering assumptions for allocating different heat pump types to different LV feeder types	
Forecasting heat pump uptake rates and low-voltage distribution network impacts	44
▶ Developing the three scenarios for heat pump uptake on ENWL's network	
▶ Impact of heat pump uptake on ENWL's low-voltage distribution network – network interventions & cost of upgrading the network	
Optimisation of heat pump load profiles	69
▶ Overview of optimisation approach	
▶ Flexibility of HP operation	
▶ Outputs from Imperial's optimisation modelling – optimised load profiles	
▶ Impact of the optimised profiles on ENWL's network	
Customer side measure analysis	80
▶ Description of customer side measures & approach for assessing these measures	
▶ Analysis & quantification of reduction in the impact implementation of these measures have on ENWL's network	
Recommendations	111
Annexes	113

Delta-ee's overall approach to assessing the impact of future electric heating uptake on ENWL's network:

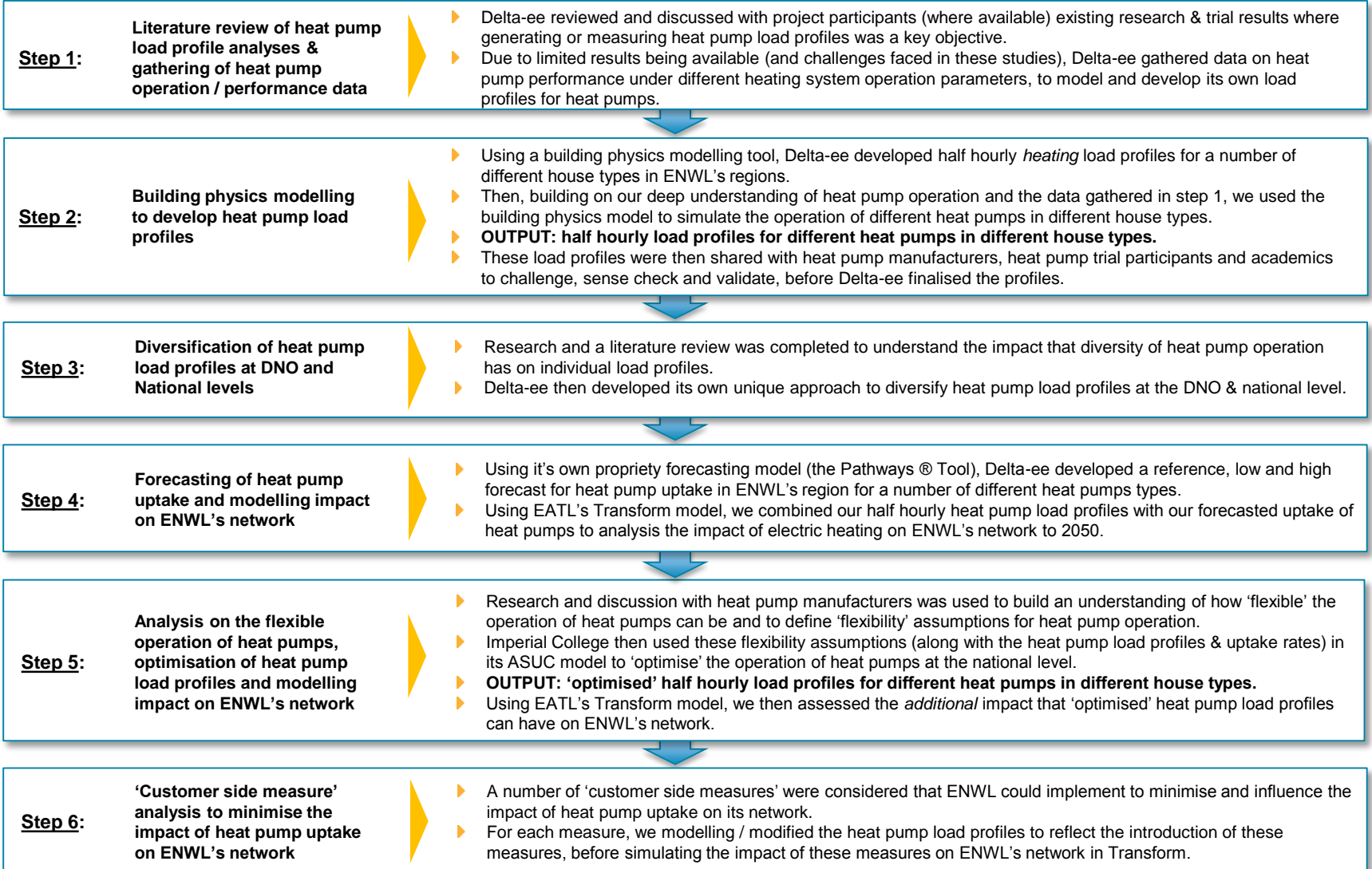

Executive Summary	4
Introduction & project scope	12
Overview of different heat pump technologies	14
▶ High level description of the different types of heat pump technologies	
▶ Technology costs, performance & 'fit' into different house types – current & future	
▶ Summary of housing stock in ENWL's region & defining the 6 heat pump – house type combinations	
High level overall methodology	22
Heat pump load profile outputs	24
▶ Methodology for developing granular & robust heat pump load profiles	
▶ Review of existing studies & projects measuring heat pump load profiles	
▶ Temperature profiles considered in this analysis & selection of outputs from our building physics modelling	
▶ Results from developing load profiles for different heat pumps in different house types	
Diversifying heat pump load profiles & clustering of heat pumps	32
▶ Overview of approach	
▶ Outputs of diversification of heat pump load profiles	
▶ Clustering assumptions for allocating different heat pump types to different LV feeder types	
Forecasting heat pump uptake rates and low-voltage distribution network impacts	44
▶ Developing the three scenarios for heat pump uptake on ENWL's network	
▶ Impact of heat pump uptake on ENWL's low-voltage distribution network – network interventions & cost of upgrading the network	
Optimisation of heat pump load profiles	69
▶ Overview of optimisation approach	
▶ Flexibility of HP operation	
▶ Outputs from Imperial's optimisation modelling – optimised load profiles	
▶ Impact of the optimised profiles on ENWL's network	
Customer side measure analysis	80
▶ Description of customer side measures & approach for assessing these measures	
▶ Analysis & quantification of reduction in the impact implementation of these measures have on ENWL's network	
Recommendations	111
Annexes	113

Approach to developing out heat pump load profiles

Step 1: Review of existing studies & trials focusing on understanding heat pump load profiles

- ▶ By gathering results from existing trials and studies that have measures / developed heat pump load profiles, we ensure that will add to & build upon existing research, and use these results to sense check & challenge our research.

Step 2: In-depth research & discussions with heat pump manufacturers and installers to understand heat pump performance, control strategies and operation in real life installations

- ▶ To develop robust load profiles for different types of heat pumps in different house types (specific to ENWL's region) we need to have a deep understanding of heat pump performance at different outside temperatures / flow temperatures.
- ▶ We use are deep existing understanding of heat pump and relationships with heat pump manufacturers & installers to build our view on this.

Step 3: Modelling of heat pump load profiles in different house types, using a **building physics model**

- ▶ We use a building physics model to simulate the heat demand of a different types of dwellings that are most common in ENWL's region on a half hourly basis.
- ▶ Inputting temperature data & heat pump performance data (from step 2) we then simulate operation of the heat pump to develop our heat pump load profiles.
- ▶ Using this modelling approach enables us to consider dwellings common in ENWL's area, different heat pump types & different outside temperatures

Step 4: Testing & challenging of the load profiles with heat pump manufacturers and our heat pump industry network

- ▶ Now that we have developed load profiles for 6 heat pump house type combinations, we share these with our heat pump network to get feedback and challenge. This helps to validate the load profiles with heat pump manufacturers and installers.

Step 5: Modification of the building physics model & heat pump assumptions to **update & improve the load profiles**

- ▶ The feedback and challenge received from heat pump manufacturers and installers is used to update our modelling assumptions.

Step 6: Final testing and validation of the heat pump load profiles with heat pump manufacturers and our heat pump industry network

- ▶ We share our updated heat pump load profiles with our heat pump network for final validation of the load profiles.

OUTPUT: Robust and validated half-hourly load profiles for different types of heat pumps in different house types

Overview of existing research & results on heat pump load profile analysis

Delta-ee has identified a number of trials / studies that have measured heat pump operation in 'real life' and has reviewed the results (where access to data was possible) and discusses with relevant people the key learnings and limitations of those results.

The key projects that Delta-ee has reviewed and used to feed into this study are:

1. **Low Carbon London (LCL)** led by UK Power Networks [18 heat pumps monitored, the 'normalised' daily profile for February 2014 is illustrated below]
2. **Customer Led Network Revolution (CLNR)** led by Northern Powergrid [89 heat pumps monitored, half hourly demand data below is the average across all heat pumps]
3. **EA Technology's** heat pump load profiles used in Transform Model v5.0
4. **DECC heat pump monitor data** – access to data has not been possible within the timescale of this project; feedback has been requested on our profiles.

The chart below illustrates the 'typical' load profiles measured under the LCL and CLNR trials during winter 2013/14. We have also extracted the existing heat pump load profiles within Transform for a 'winter average' and a 'winter peak' day – the 'winter average' is similar to that of the LCL trial.

Heat pump load profiles from different UK projects for different winter days

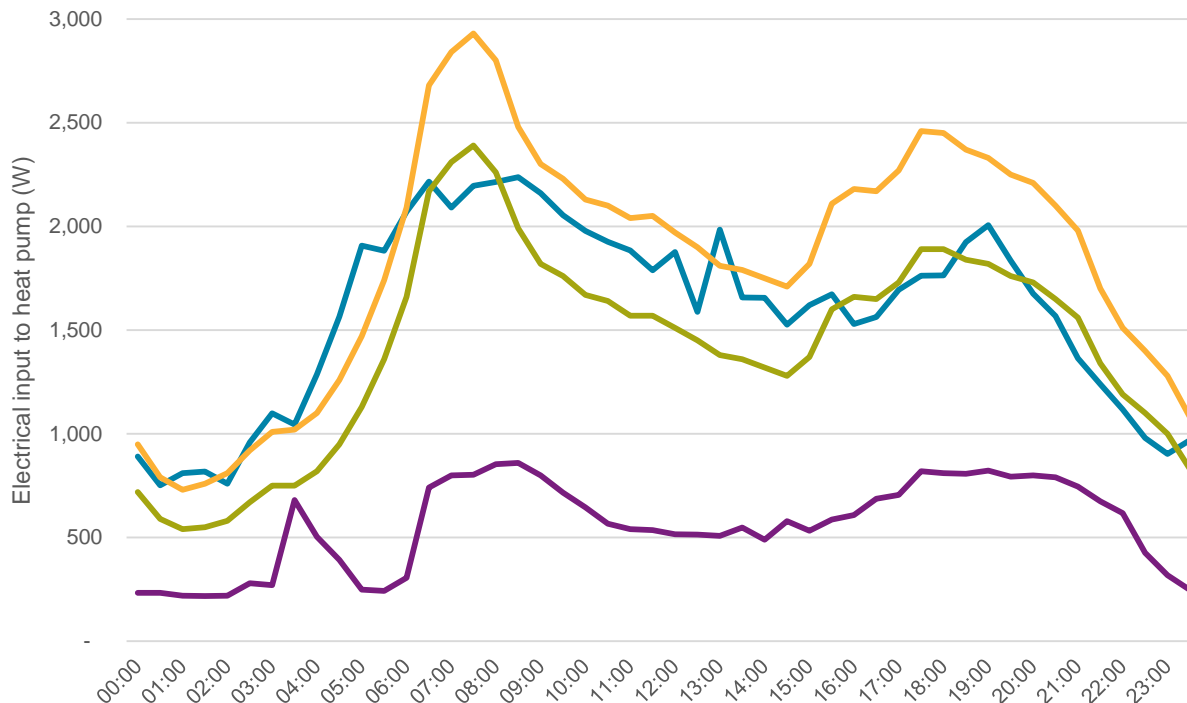

Commentary on existing research:

Key similarities among existing studies:

- ▶ Profiles follow an 'M' shape, with a peak during the morning heating period and a peak during the evening heating period.
- ▶ Low Carbon London & EA Technology's Transform 'winter average' profiles have a peak load of 2 – 2.5 kW.

Key difference among existing studies:

- ▶ The CLNR and Low Carbon London projects monitored different numbers of heat pumps, with a big variation in the peak load observed (peak load from Low Carbon London's profile is more than double that of the CLNR project).
- ▶ This will likely be due to different house types / heat pump types being monitored, and variations in outside temperatures during the monitoring periods.

- Low Carbon London trial (Feb 2014)
- CLNR trial (Feb 2014)
- Transform ('winter average')
- Transform ('winter peak')

Outside air temperature is a critical factor that influences heat pump load profiles

The load profile of a single heat pump in one dwelling varies significantly across the year for three key reasons:

- ▶ The efficiency of the heat pump is significantly influenced by the **outside air temperature**.
- ▶ The **type of dwelling** the heat pump is installed in – the age and size of a dwelling influences overall heat demand and how hard the heat pump has to work to heat the dwelling.
- ▶ The **controls strategy / system set up** – which influences heat pump versus back up heater use (or heat pump versus boiler use for hybrids) on very cold days.

Below, we illustrate how the outside air temperature varies across the cross of one day during an 'average' peak winter day and a '1 in 20' (extreme) peak winter day. This temperature data has come from the **ASHRAE International Weather Files for Energy Calculations** (IWECC database), with **Manchester in North West of England** as the reference location. For the 1 in 20 winter day, we have scaled down the temperatures for a number of average winter days to achieve a day where the average temperature is **-5.49°C** (based on National Grid data defining -5.49°C as the daily temperature for the North West on a 1 in 20 winter day).

Temperature during an 'average' peak winter day

'Average' peak

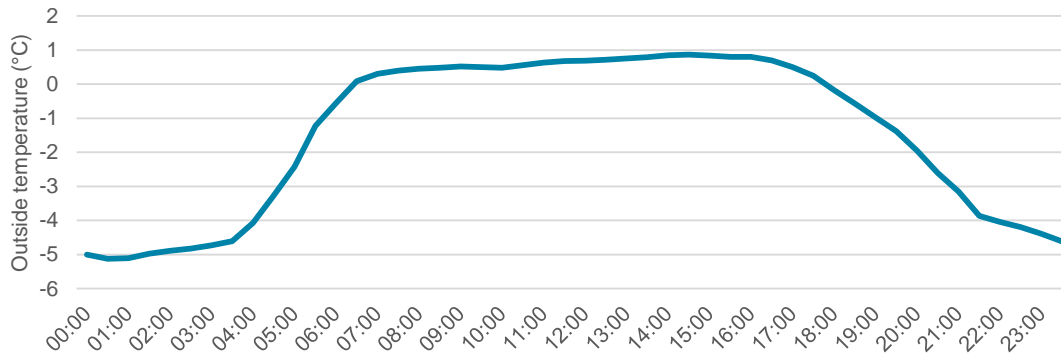

During an 'average' peak winter day, heating systems will typically operate during the morning and evening heating periods to provide space heating.

Back up heaters will typically not be required to operate, unless temperatures drop below zero or -1 degrees during the heating periods.

Temperature during a '1 in 20' (extreme) peak winter day

'1 in 20' peak

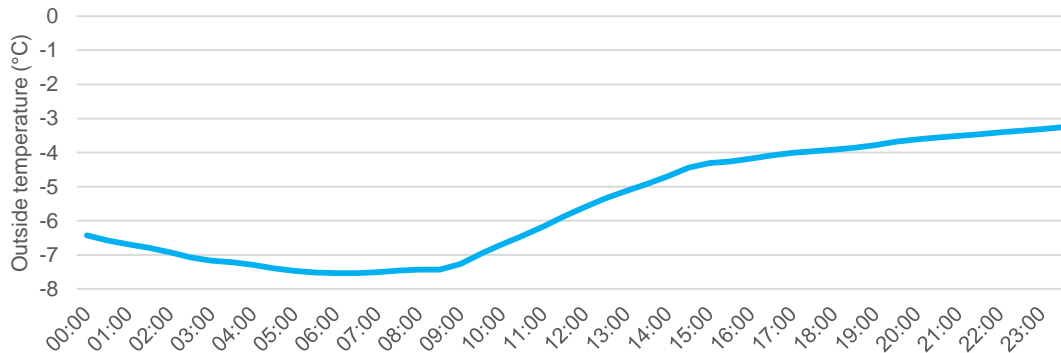

During a '1 in 20' (extreme) peak winter day, the average temperature we have modelled is -5.49°C.

Across a number of days during our '1 in 20' winter week, temperatures typically vary from -8 to 0°C and during much of this time, the back up heaters of ASHPs will be operating, while the heat pump part of hybrids will not be operating.

Example load profiles for heat pumps: Higher temperature & lower temperature ASHP in a semi detached dwelling, on different days of the year

- Below, we illustrate week day load profiles (un-diversified) for a **higher temperature & a lower temperature ASHP in a semi detached dwelling** on two different days:
- ▶ On an **'average' peak** winter day, all the space heating and hot water demand is met by the heat pump part of the system, with electricity demand peaking at ~2.5kW for the higher temperature ASHP and at ~2.2 kW for the lower temperature ASHP.
 - ▶ During the **'1 in 20' peak** winter day, outside air temperature is below 0°C for prolonged periods meaning that the back up electric heater in ASHP systems is needed for large portions of the day. The back up heater is 3kW in size resulting in an additional 3kW of electricity demand on very cold days. We also see more operation of the heat pump over night and during the set back period (middle of the day) to maintain a comfortable temperature within the dwelling.

Higher temperature ASHP in a semi

Lower temperature ASHP in a semi

'Average' peak

'1 in 20' peak

Load profile for a HT ASHP in a semi on an 'average' peak winter day

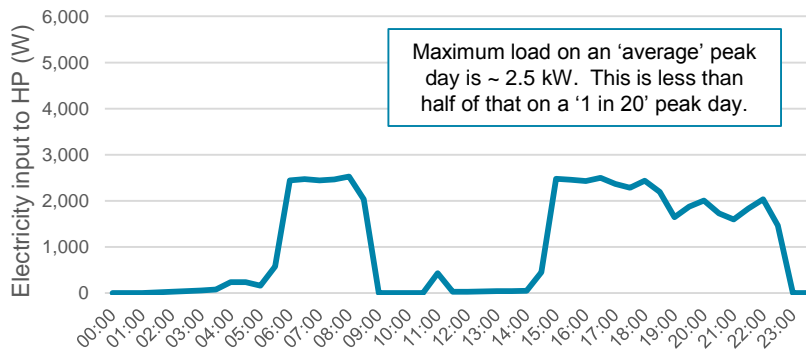

Load profile for a LT ASHP in a semi on an 'average' peak winter day

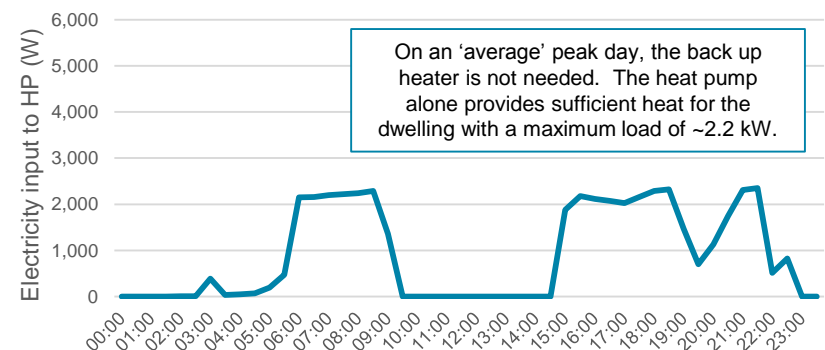

Load profile for a HT ASHP in a semi on a '1 in 20' peak winter day

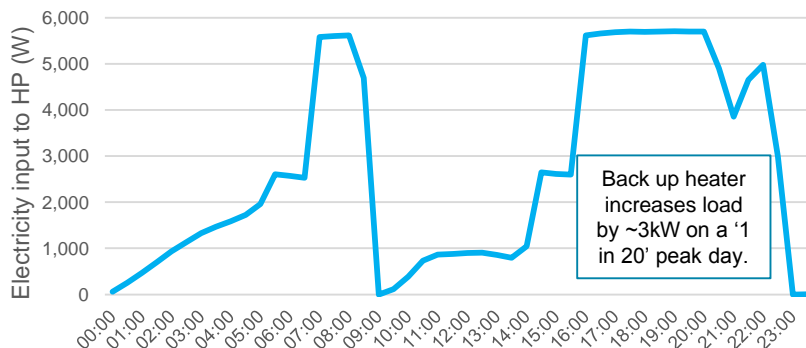

Load profile for a LT ASHP in a semi on a '1 in 20' peak winter day

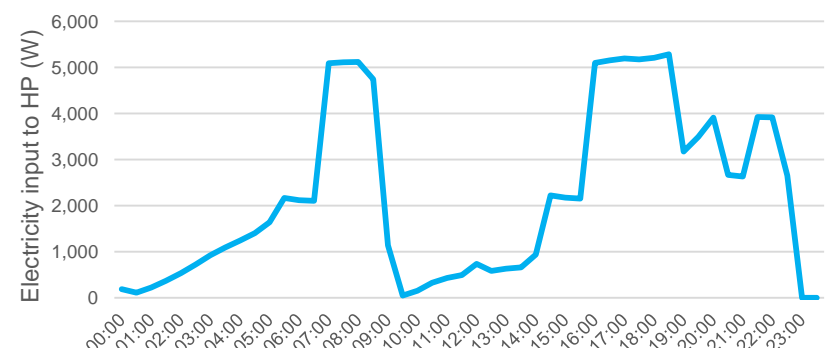

Example load profiles for heat pumps: Hybrid heat pumps in a detached and a terraced dwelling, on different days of the year

- Below, we illustrate week day load profiles (un-diversified) for a **hybrid heat pump in a detached dwelling** and a **hybrid heat pump in a terraced dwelling** on two different days:
- ▶ On an **'average' peak** winter day, the majority of the space heating and hot water demand in both the detached and the terraced dwelling is met by the heat pump part of the system, with electricity demand peaking at ~3kW.
 - ▶ During the **'1 in 20' peak** winter day, the efficiency of the heat pump part of the hybrid system drops and therefore only the gas boiler part of the system operates in the detached and terraced dwellings. This results in no electricity demand occurring from the heat pump part of the hybrid system on very cold days, which results in a reduction in maximum load of 1.6 – 2.6 kW.

Hybrid heat pump in detached

'Average' peak

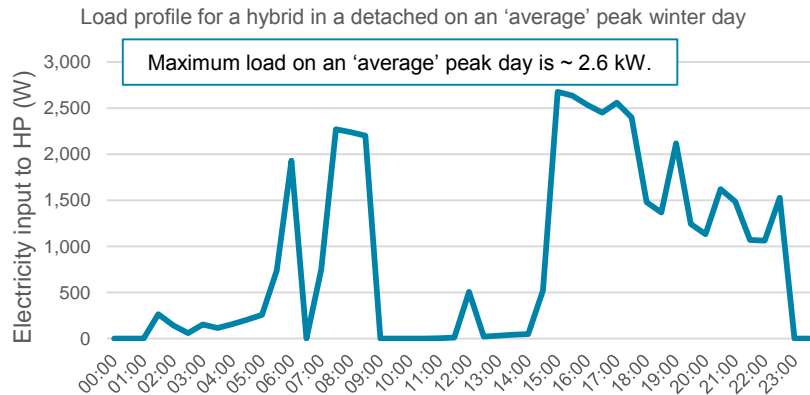

'1 in 20' peak

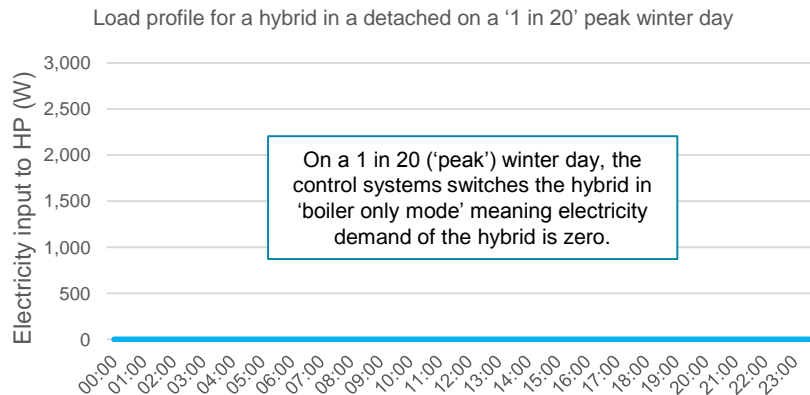

Hybrid heat pump in terraced

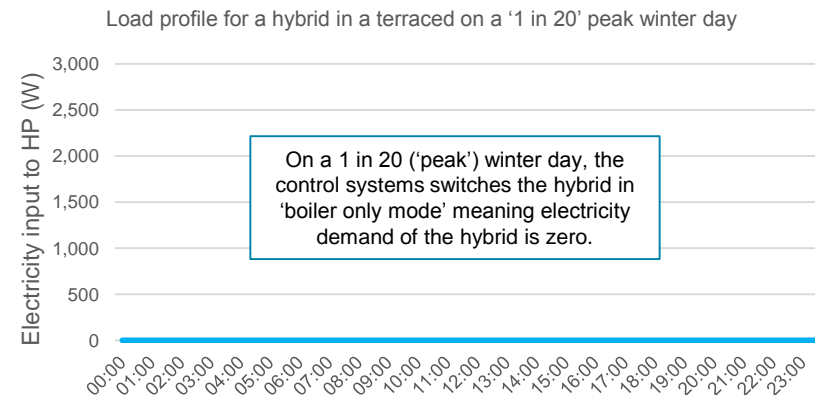
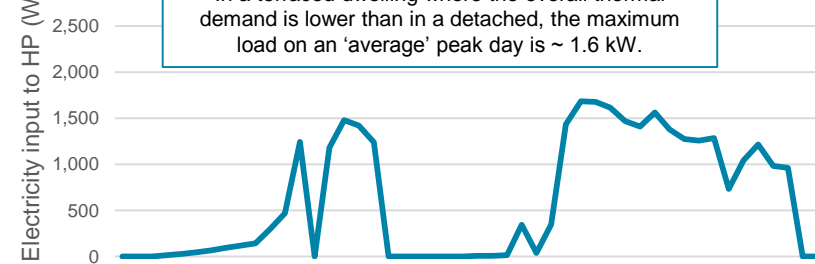

Example load profiles for heat pumps: Hybrid heat pump in a semi detached & a lower temperature ASHP in a new build, on different days of the year

Below, we illustrate week day load profiles (un-diversified) for a **hybrid heat pump in a semi detached dwelling** and a **lower temperature ASHP in a new build** on two different days:

- ▶ On an **'average' peak** winter day, the majority of the space heating and hot water demand in the semi detached dwelling is met by the heat pump part of the hybrid system, with electricity demand peaking at ~1.8kW. For the LT ASHP in a new build, we see a similar peak demand, with the back up heater not switching on.
- ▶ During the **'1 in 20' peak** winter day, the efficiency of the heat pump part of the hybrid system drops and therefore only the gas boiler part of the system operates in the semi detached dwelling. This results in a reduction in maximum load of ~1.8 kW on very cold days. For the LT ASHP in the new build however, maximum load increases by ~3kW on very cold days as the back up electric heater switches on.

Hybrid heat pump in a semi

Lower temperature ASHP in a new build

'Average' peak

'1 in 20' peak

Load profile for a hybrid in a semi on an 'average' peak winter day

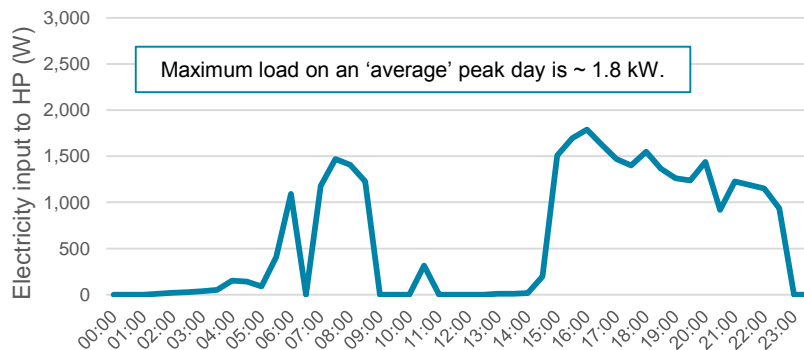

Load profile for LT ASHP in a new build on an 'average' peak winter day

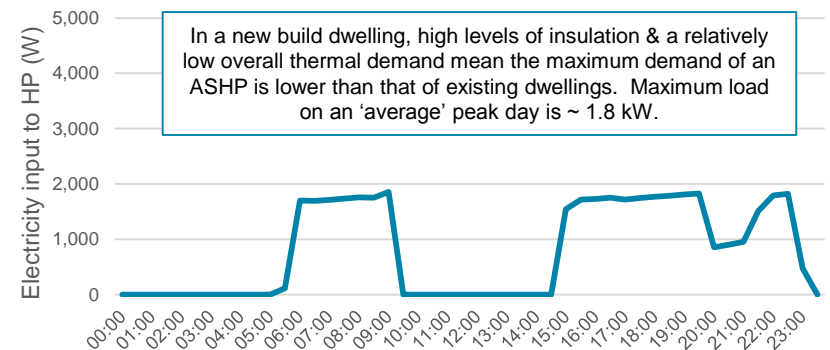

Load profile for a hybrid in a semi on a '1 in 20' peak winter day

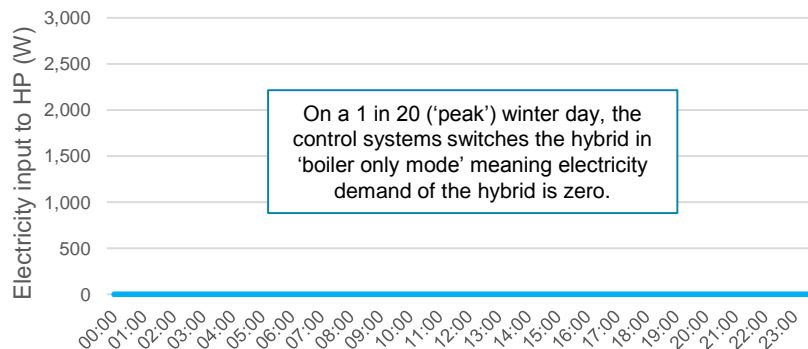

Load profile for LT ASHP in a new build on a '1 in 20' peak winter day

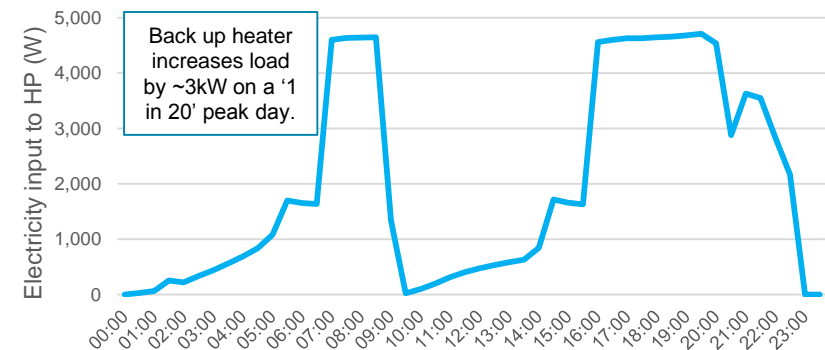

Comparison of all six heat pump-house type load profiles on an 'average' peak and a '1 in 20' peak winter day

Electricity demand from heat pumps will have the most significant impact on ENWL's networks on an 'average' peak and a '1 in 20' peak winter day, with the load profiles of different heat pumps in different types of houses vary significantly across these days (varying in terms of the maximum demand & the timing of the maximum demand).

- ▶ On '1 in 20' peak winter day, the back up heaters of pure electric heat pumps will be running which can more than double electricity demand from heat pumps. However, the heat pump part of hybrids will not be operating.
- ▶ On 'average' peak winter days, electric heat pumps and the heat pump part of hybrids will all be operating, near their maximum output for sustained periods of the day. The back up heaters of pure electric heat pumps will not be operating.

Below, we illustrate the load profiles for the six heat pump house types considered in this study on an 'average' peak and a '1 in 20' peak winter day.

Load profiles for different heat pump house types on an 'average' peak winter day

'Average' peak

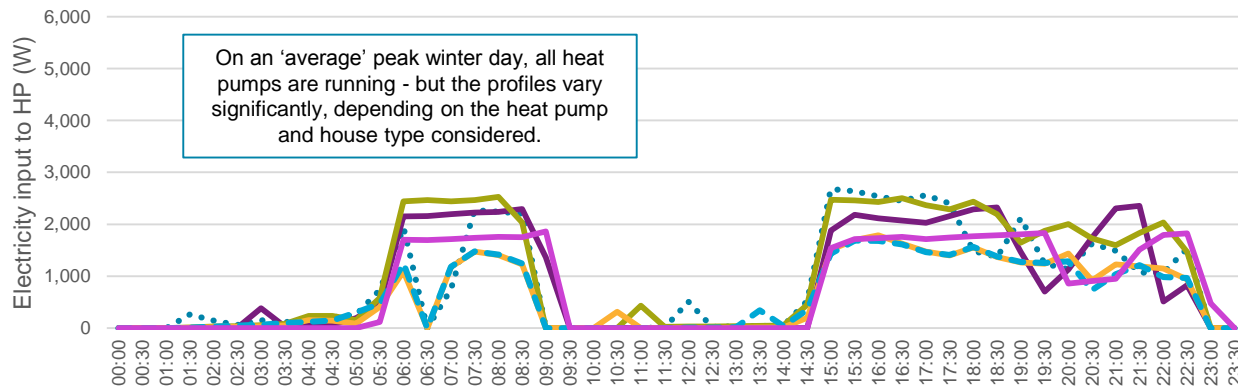

Load profiles for different heat pump house types on a '1 in 20' peak winter day

'1 in 20' peak

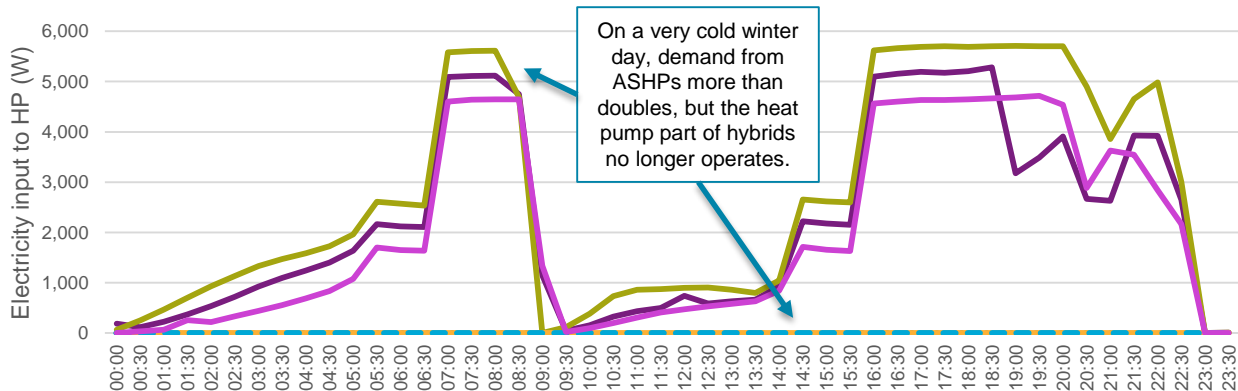

Heat pump load profiles **vary widely** depending on the type of heat pump installed in different house types.

- ▶ For this study, we have developed load profiles for 6 combinations of different types of heat pumps in different types of dwellings.
- ▶ As illustrated on the left, on an average winter day, these profiles vary significantly in terms of the maximum electricity demand and the timing of the peak demand.
- ▶ We could have considered more heat pump-house types but focus on these six combinations as these are likely to see the most significant uptake in ENWL's region to 2050.

- Hybrid HP in detached
- LT ASHP in semi
- HT ASHP in semi
- Hybrid HP in semi
- - - Hybrid HP in terrace
- LT ASHP in new build

Executive Summary	4
Introduction & project scope	12
Overview of different heat pump technologies	14
▶ High level description of the different types of heat pump technologies	
▶ Technology costs, performance & 'fit' into different house types – current & future	
▶ Summary of housing stock in ENWL's region & defining the 6 heat pump – house type combinations	
High level overall methodology	22
Heat pump load profile outputs	24
▶ Methodology for developing granular & robust heat pump load profiles	
▶ Review of existing studies & projects measuring heat pump load profiles	
▶ Temperature profiles considered in this analysis & selection of outputs from our building physics modelling	
▶ Results from developing load profiles for different heat pumps in different house types	
Diversifying heat pump load profiles & clustering of heat pumps	32
▶ Overview of approach	
▶ Outputs of diversification of heat pump load profiles	
▶ Clustering assumptions for allocating different heat pump types to different LV feeder types	
Forecasting heat pump uptake rates and low-voltage distribution network impacts	44
▶ Developing the three scenarios for heat pump uptake on ENWL's network	
▶ Impact of heat pump uptake on ENWL's low-voltage distribution network – network interventions & cost of upgrading the network	
Optimisation of heat pump load profiles	69
▶ Overview of optimisation approach	
▶ Flexibility of HP operation	
▶ Outputs from Imperial's optimisation modelling – optimised load profiles	
▶ Impact of the optimised profiles on ENWL's network	
Customer side measure analysis	80
▶ Description of customer side measures & approach for assessing these measures	
▶ Analysis & quantification of reduction in the impact implementation of these measures have on ENWL's network	
Recommendations	111
Annexes	113

Diversification of heat pump load profiles – introduction

Key factors influence the diversity of heat pump operation

While we have already generated heat pump load profiles for specific heat pumps types in specific dwelling types, not all heat pumps will be operated in exactly the same way in each house type. For example some homes may not be occupied on a particular evening when a heating system would otherwise be switched on (e.g. holidays), or some homes may switch their heating system on earlier (or later) than in other homes depending on work patterns. In some dwellings, heating systems operate continuously throughout the day, while in others there will be a morning and evening heating period.

Therefore, when considering the impact of heat pump uptake on the network, it is important to consider the 'diversified' load profile of the **population of heat pumps**, as not all heat pumps will be switched on at the same time, or operate in exactly the same way. Without diversifying the operation of heat pumps, the impact of heat pumps on the network will likely be over exaggerated and could result in unnecessary investments in the network.

The key factors we have considered in diversifying the heat pump load profiles are:

- ▶ Occupancy levels in dwellings (i.e. how many homes will be occupied at any one time, at different times of the day).
- ▶ Unimodal versus bimodal heating system operation (i.e. is there one heating period – all day operation, or two heating periods – morning and evening).
- ▶ The timing at which homes will want to be warm. This will primarily be controlled by time clocks / simple heating system controls.
- ▶ The volume of heat pumps over which diversification needs to occur – i.e. are we considering 10s of heat pumps (such as at the DNO level) or 100,000s of heat pumps (such as at the national level).

Illustrative impact of diversification on the load profile of a heat pump

Undiversified load profile for HT ASHP in a semi on an 'average' peak winter day

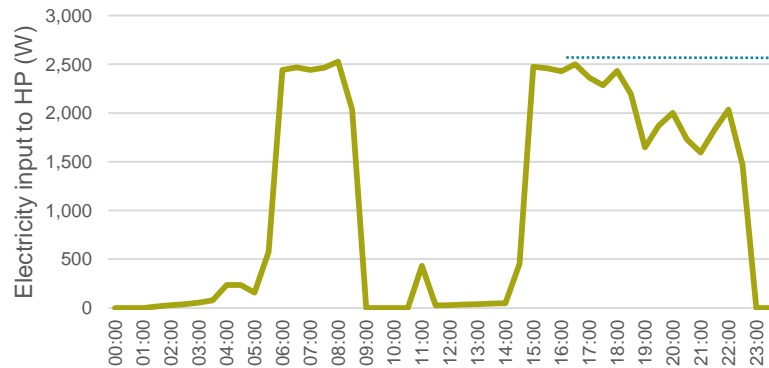

Diversified load profile for HT ASHP in a semi on an 'average' peak winter day

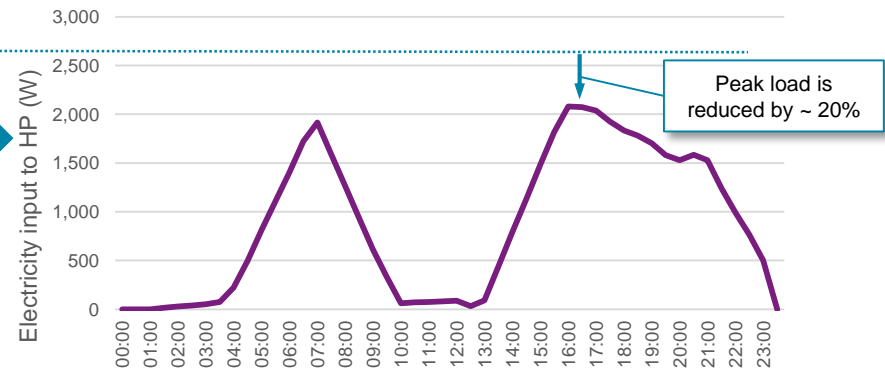

Approach to diversifying heat pump operation: share of homes with heating systems operating at different periods of the day

- ▶ The main approach to diversifying the heat pump load profiles was based on heating time profiles from the DECC assessment of heating controls impact on domestic energy demand (2014) project.
- ▶ This study provided insight on the proportion of UK homes that had their heating systems 'switched on' during different periods of the day. The study also considered the breakdown of heating systems that operated with a single heating period (i.e. switched on all day) and a double heating period (i.e. a morning and evening heating period). The charts below illustrate this breakdown for a typical week day. In this study, around 20% of dwellings had a single heating period, with 80% having a double heating period.

UK Heating Density for single & double period operation of heating systems

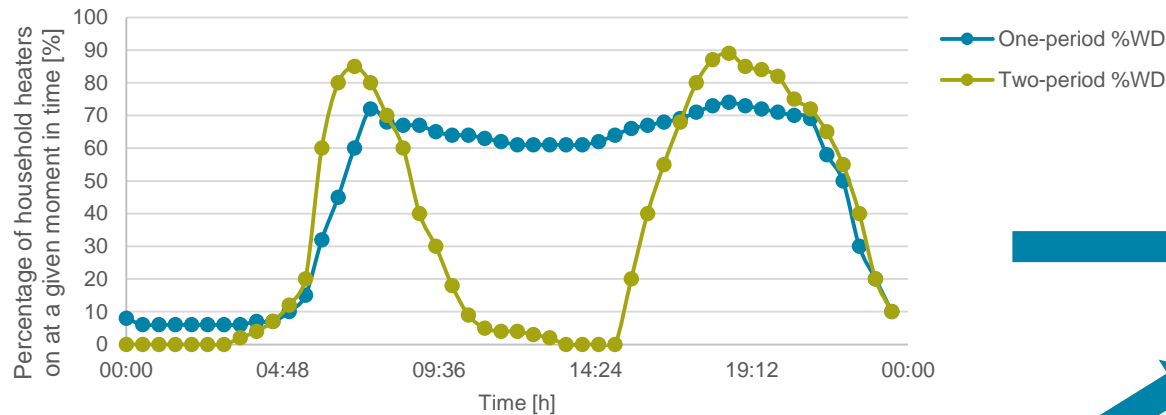

UK National Heating Density – average for ALL dwellings

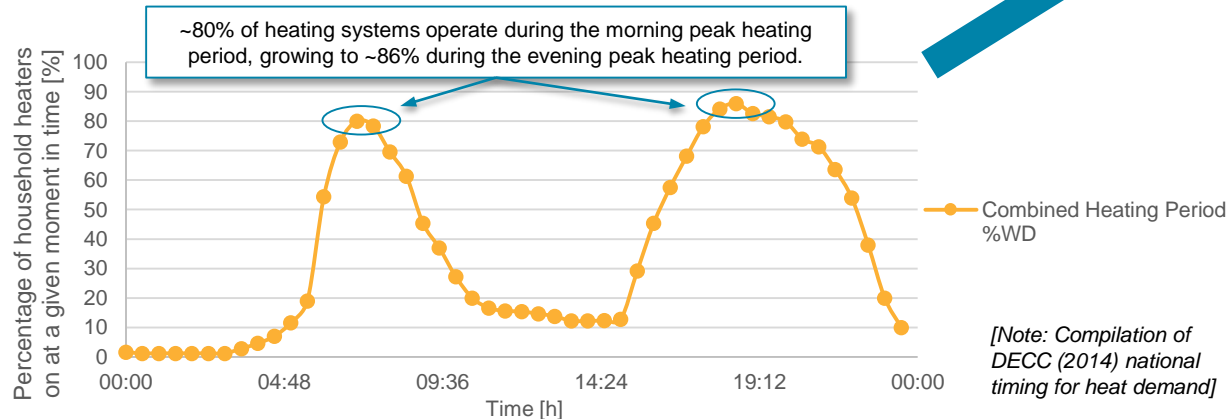

Key learnings that will be applied to our diversification process:

- ▶ Around 80% of homes have their heating system operating during the morning heating period.
- ▶ In the evening heating period, **80 – 86%** of homes have their heating systems operating.
- ▶ Over night, <10% of dwellings have their heating systems operating (a period during which the vast majority of heating systems are behaving in the same way).

The key sources we have used for diversity profile development

- DECC assessment of heating controls impact on domestic energy demand (2014)
- UK Energy Follow-Up Survey (EFUS) 2011
- Loughborough University domestic active occupancy modelling (2008)
- Loughborough University four-state domestic active occupancy modelling (2014)

Approach to diversifying heat pump operation: share of homes with heating systems operating at different periods of the day

- ▶ Another study that was used to support building our diversification approach was Loughborough University's 'Domestic Active Occupancy modelling' studies from 2008 & 2014. These studies looked at the **share of house holds in the UK with an 'active' occupant** – which we used as an approximation for the **share of dwellings that are occupied in the UK**.
- ▶ The results from this study helped to back and sense check the results from the DECC study.
- ▶ The figure below illustrates results from this Loughborough study on a typical week day.

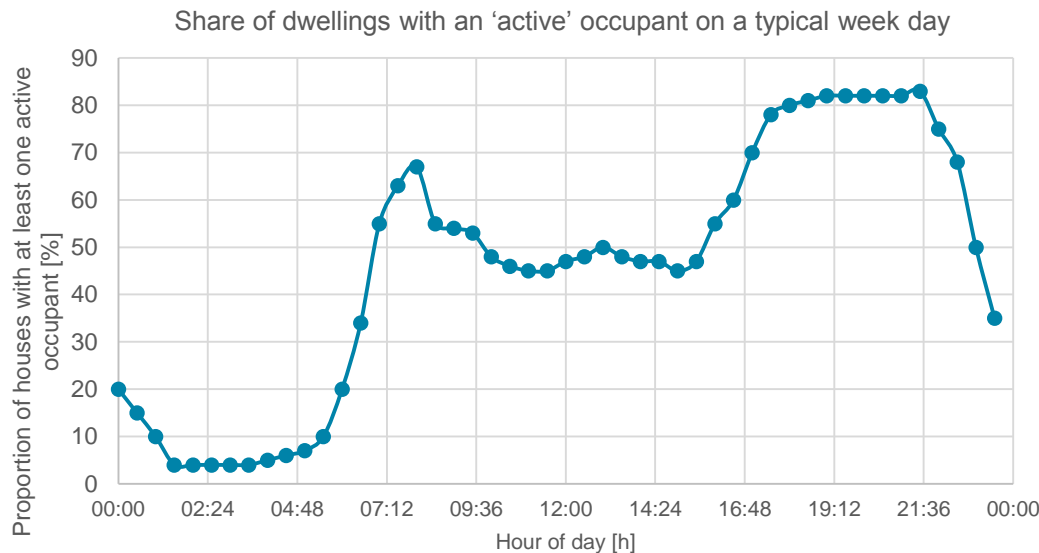

Key learnings that will applied to our diversification process:

- ▶ This study suggests a peak of ~ 67% of dwellings have an active occupant during the morning heating period – lower than share of dwelling that DECC suggests has their heating system operating.
- ▶ In the evening heating period, **80 – 83%** of dwellings have an active occupant, which lines up well with the DECC analysis.
- ▶ Over night, <10% of dwellings have an active occupant (a period during which the vast majority of heating systems are behaving in the same way).

The key sources we have used for diversity profile development

DECC assessment of heating controls impact on domestic energy demand (2014)

UK Energy Follow-Up Survey (EFUS) 2011

Loughborough University domestic active occupancy modelling (2008)

Loughborough University four-state domestic active occupancy modelling (2014)

Source: Loughborough University four-state domestic active occupancy modelling (2014)

Approach to diversifying heat pump operation: 2 – 3 hour start up period

- ▶ National Grid gas demand data suggests that heating systems typically start up over a 2 - 3 hour period in the morning and evening periods, with the morning peak heating period lasting from ~07:00 to 09:00 and the evening heating period starting ~16:00/16:30 and lasting until 23:00.
- ▶ In our analysis, we therefore assume the morning and evening 'heating periods' (i.e. the during which most homes will want heating to be delivered) will be 07:00 – 09:00 and 16:00 – 23:00 respectively. During these periods, not all heating systems will be switched on (as not all homes will be occupied), but we assume that the vast majority of dwellings will be occupied, with heating systems operating.
- ▶ As the above graph illustrates a gradual 'ramp up' period in the morning and evening (where gas demand grows before remaining high during the 'heating periods', in our approach to diversifying heat pump operation, we have staggered the start up times of heat pump in the morning and afternoon over a 3 hour window (6 half-hour periods) at the National level. At the DNO level, where we expect slightly less diversity in operation of heat pumps, we increase this period to a 3 hour window (6 half-hour periods) at the national level.

Gas demand across one day (6 minute intervals) in different houses

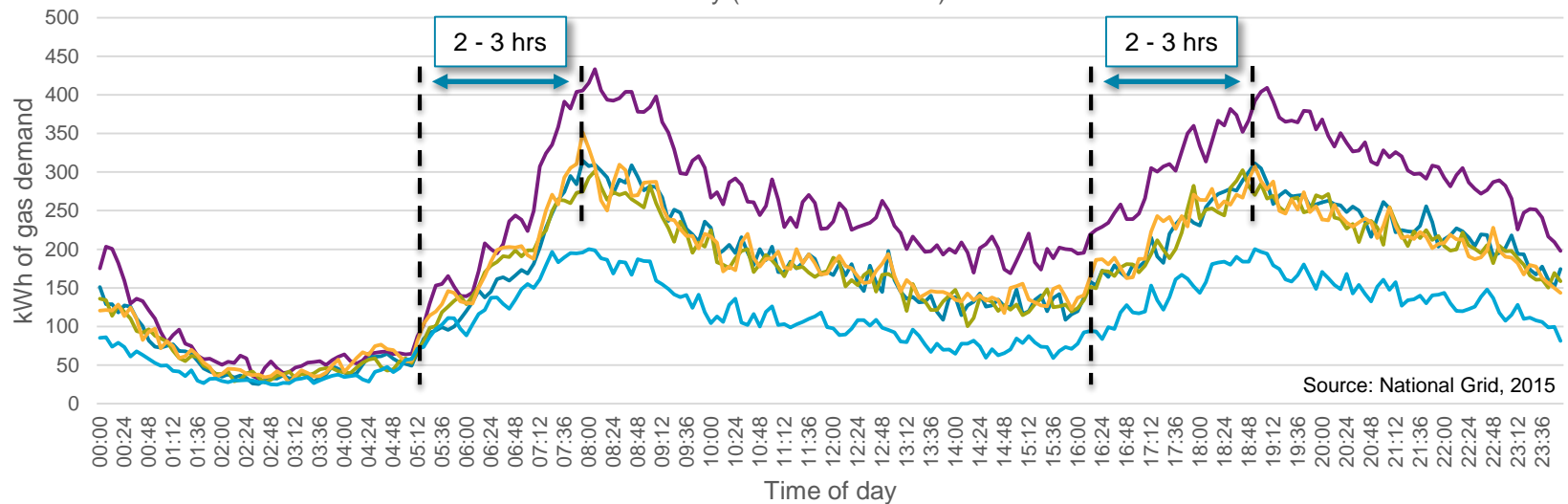

Key learnings that will applied to our diversification process:

- ▶ The 'morning heating period' (when gas demand is high for a consistent period of time) is from ~07:00 – 09:00. The 'evening heating period' runs from ~16:00 until 23:00.
- ▶ There is a **2 – 3 hour period** over which gas demand gradually grows in the morning and evening. We will use this as the period over which to 'stagger' the start up time all of heat pumps at the national and DNO levels.

Approach used to diversifying heat pump load profiles (1/2)

Diversification factors & 'start up' times applied to heat pump load profiles on an 'average' winter day at the National level

- ▶ Based on existing research by DECC and Loughborough University, we have defined in the table below a value for the **share of the installed base of heat pumps that will be operating at different periods throughout the day**. We refer to these as 'diversification factors'.
- ▶ These values are the diversification factors we apply to our heat pump load profiles on an 'average' peak winter day, and for all heat pumps installed at the national level.
- ▶ Using National Grid data, we 'stagger' the start up times of heat pumps over a 2 – 3 hour period to reflect differences in when heating is required by different dwellings.
- ▶ We have then made some high level assumptions on how these factors will change if we consider a '1 in 20' peak day, and if we consider a smaller population of heat pumps installed at the feeder (DNO) level.

Period of day	Diversification % - National level
Type of winter day	'Average' winter day
Morning heating period – peak period	80%
Morning heating period – shoulder	80%
Evening heating period – peak period	86%
Evening heating period – shoulder	86%
Set back	86%
Night	95%
Duration over which heating systems are switched on	3 hours

Illustrative heat pump load profile (undiversified), with the 'period of day' indicated.

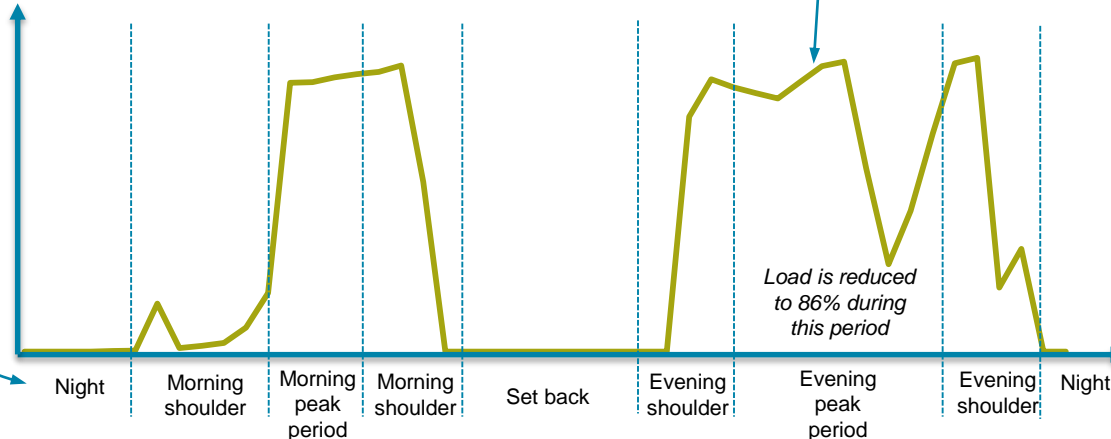

How are the heat pump load profiles diversified?

- ▶ **Step 1:** Firstly, we stagger the start time of heat pumps (beginning in 'morning shoulder 1') to reflect to 3 hour period over which heating systems start up in the morning. We do this by assuming that one sixth of all heat pumps start up during the first half hour of the 3 hour period, then another sixth starts up during the second half hour, and so on.

This means we have 6 heat pumps operating at slightly different positions of the undiversified load profile at each half hour period throughout the day. We continue this 'staggering' of the load profile throughout the day to reflect different homes being on slightly earlier / later heating cycles.

- ▶ **Step 2:** We then take the average load of the 6 heat pumps at each half hour period throughout the day.

This results in a 'smoothing' of the load profiles – reducing the height of the 'spikes' in load at certain points throughout the day.

- ▶ **Step 3:** Then, we take an 'average' peak day and break this day down into the different 'periods of day' described in the table on the left. The diversification percentages in the table are applied to the 'average' profile at each of the periods of the day.

This reduces the height of the profile, reflecting the share of home that are unoccupied / not running their heating system at various points of the day.

See the next slide for an illustration of our approach.

Approach used to diversifying heat pump load profiles (2/2)

Below, we illustrate our approach for diversifying heat pump load profiles (described on the previous slide) at the national level.

Starting point:
Undiversified load profile

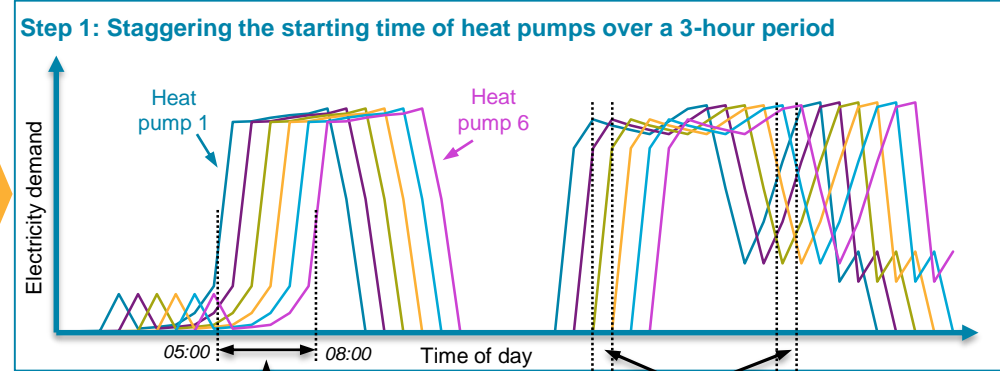
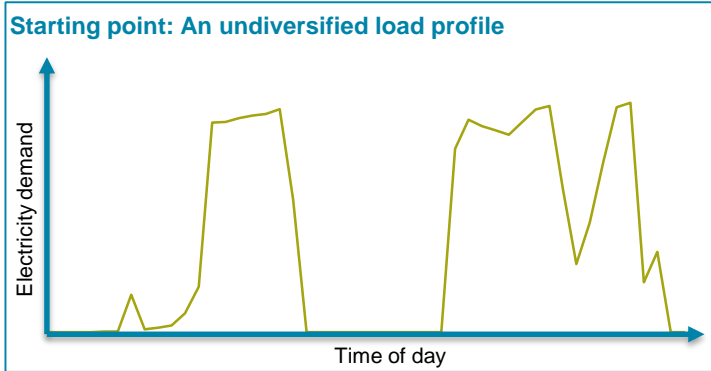

3 hour time period over which all heat pumps switch on.

Half hour periods

End point:
Diversified load profile

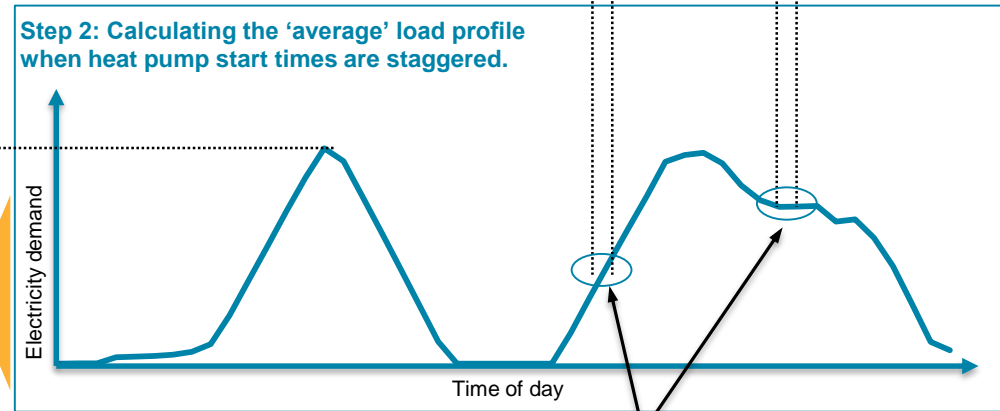
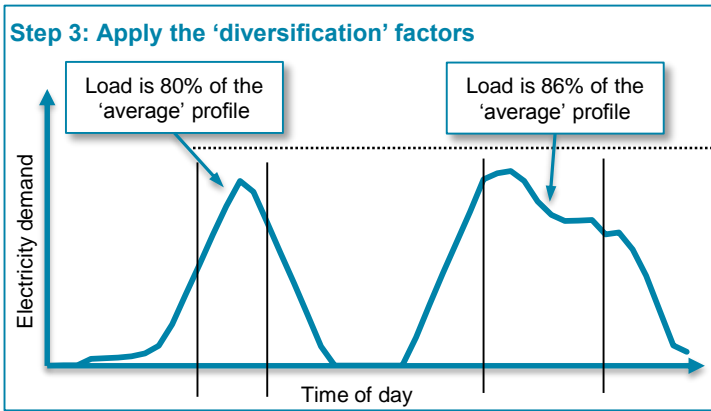

During each half hourly period of the day, we calculate the average electricity load from the 6 staggered heat pump load profiles. This results in a 'average' load profile for one day for a population of heat pumps that start up over a 3-hour period in the morning.

For each of the different 'periods' of the day, we apply 'diversification factors' (summarised on the previous slide). This reflects the share of homes not running their heating system at various points of the day.

Diversified heat pump load profiles

Diversified heat pump load profiles - results

- ▶ Below we illustrate the diversified (at the 'DNO' or LV network level*) and un-diversified heat pump load profiles for a lower temperature ASHP in a semi detached dwelling an 'average' peak winter day & a '1 in 20' peak winter day.
- ▶ Typically, the diversification approach results in the maximum load of the profile of LT ASHP in a semi on an 'average' peak day falling by ~20%, with the load profile being smoother and less 'peaky'.
- ▶ On the '1 in 20' peak day, the maximum load of the diversified profile for a LT ASHP in a semi remains the same as the undiversified profile, but for a shorter period of time.

Undiversified vs diversified (@ DNO level) load profiles for a LT ASHP in a semi on an 'average' peak winter day

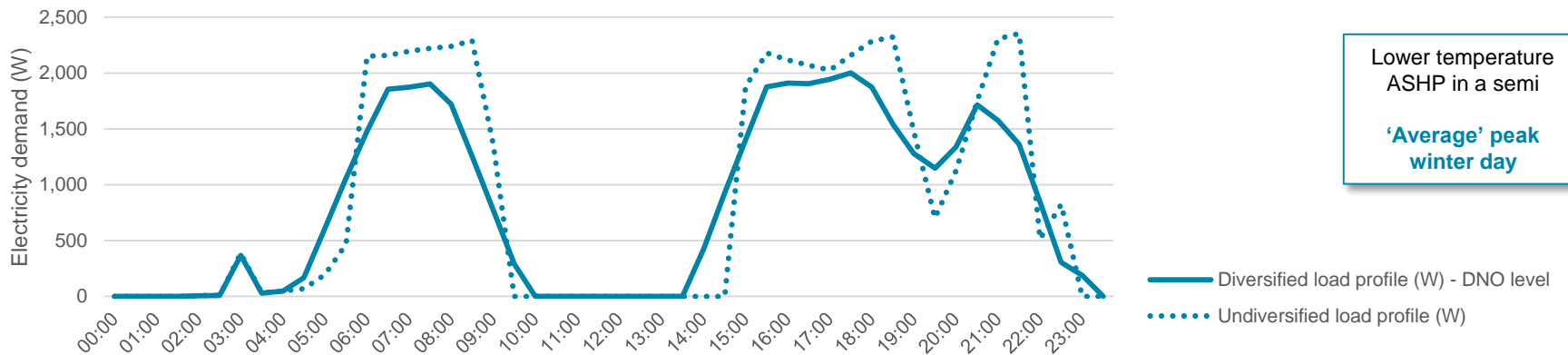

Undiversified vs diversified (@ DNO level) load profiles for a LT ASHP in a semi on an '1 in 20' peak winter day

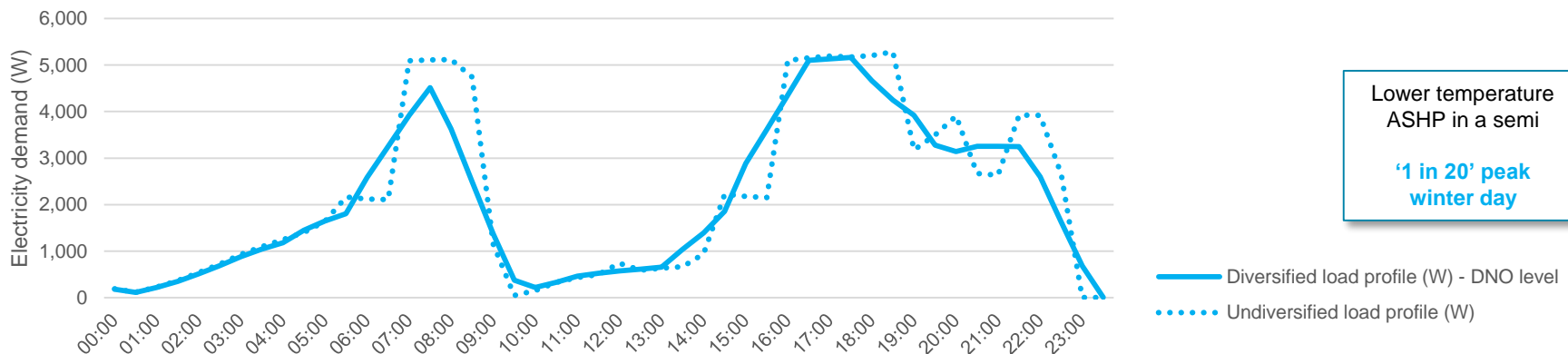

* At the LV network level, we diversify heat pump operations for low 10s of heat pumps.

Diversified heat pump load profiles

Diversified heat pump load profiles - results

- ▶ Below we illustrate the diversified (at the 'DNO' or LV network level*) and un-diversified heat pump load profiles for a lower temperature ASHP in a new build semi on an 'average' peak winter day and a '1 in 20' peak winter day.
- ▶ Typically, the diversification approach results in the maximum load of the profile of a LT ASHP in a new build on an 'average' peak day falling by ~10 - 20%, with the load profile being smoother and less 'peaky'.
- ▶ On the '1 in 20' peak day, the maximum load of the diversified profile for a LT ASHP in a new build remains the same as the undiversified profile, but for a shorter period of time.

Undiversified vs diversified (@ DNO level) load profiles for a LT ASHP in a new build on an 'average' peak winter day

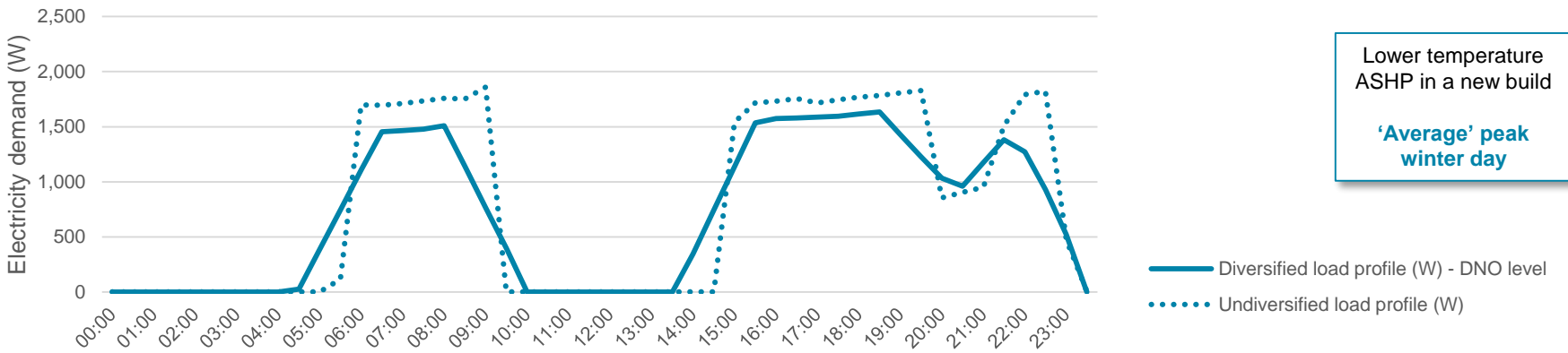

Undiversified vs diversified (@ DNO level) load profiles for a LT ASHP in a new build on a '1 in 20' peak winter day

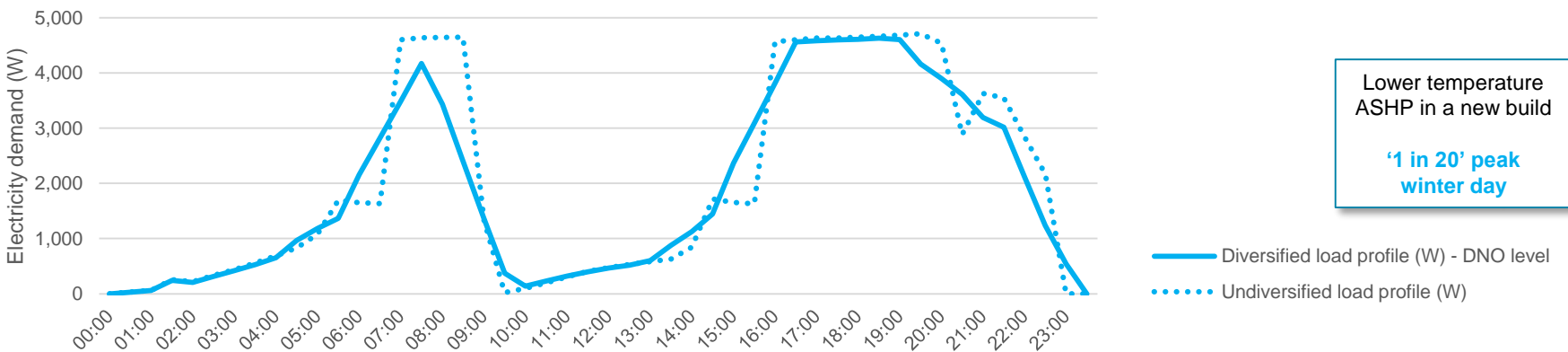

* At the LV network level, we diversify heat pump operations for low 10s of heat pumps.

Diversified heat pump load profiles

Diversified heat pump load profiles - results

- ▶ Below we illustrate the diversified (at the 'DNO' or LV network level*) and un-diversified heat pump load profiles for a hybrid in a detached dwelling and a hybrid in a terraced dwelling on an 'average' peak winter day. We do not show the profiles on a '1 in 20' peak winter day as the heat pump part of the hybrids do not operate on these days.
- ▶ Typically, the diversification approach results in the maximum load of the profile of a hybrid in a detached dwelling on an 'average' peak day falling by ~10 - 20%, with the load profile being smoother and less 'peaky'. During the morning heating period, the load is reduced by 40 - 50%.
- ▶ For a hybrid in a terraced dwelling, where the overall thermal demand is lower than a detached, the maximum load of the diversified profile is 10 - 20% lower than the undiversified profile.

Undiversified vs diversified (@ DNO level) load profiles for a hybrid in a detached on a 'average' peak winter day

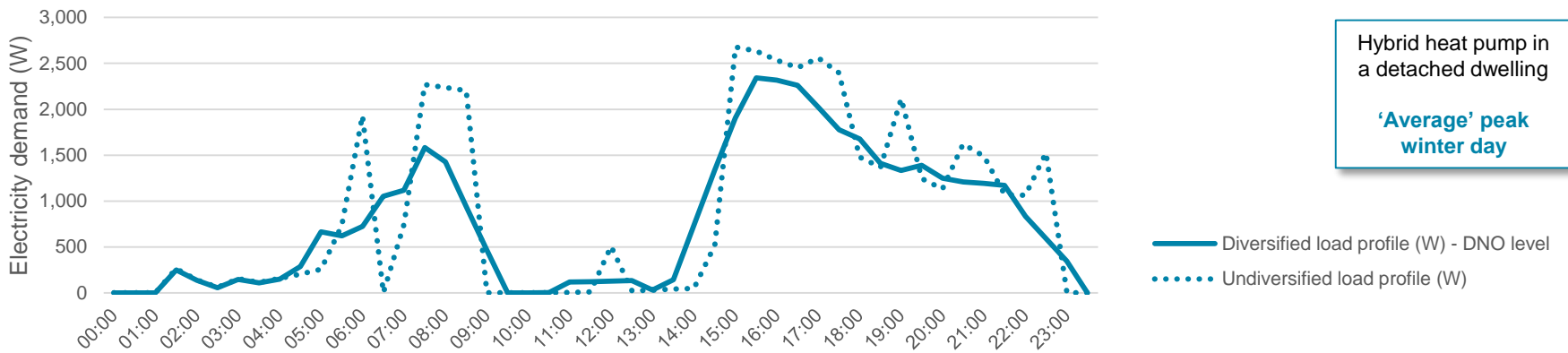

Undiversified vs diversified (@ DNO level) load profiles for a hybrid in a terrace on a 'average' peak winter day

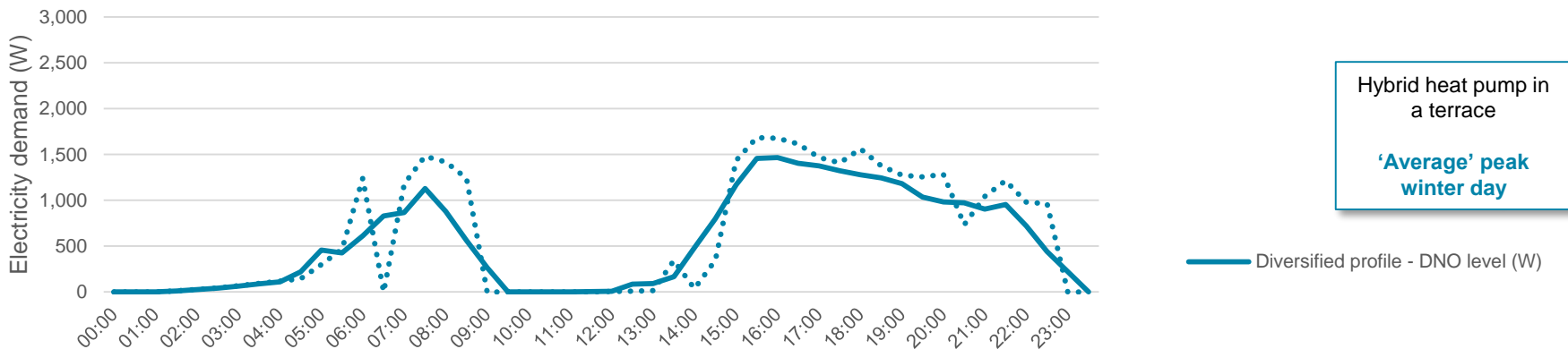

* At the LV network level, we diversify heat pump operations for low 10s of heat pumps.

Diversified heat pump load profiles - results

- ▶ Below we illustrate the diversified (at the 'DNO' or LV network level*) profiles for all six of our heat pump-house types – on an 'average' peak winter day.
- ▶ Each of the profiles differ significantly in terms of the maximum load across the course of one day (from <math><1.5\text{kW}</math> to just over - ▶ Depending on the level of uptake of each of the different types of heat pumps on ENWL's network, the impact on the network and various times of the year will vary.

Diversified load profiles for the different heat pump house types on an 'average' peak winter day

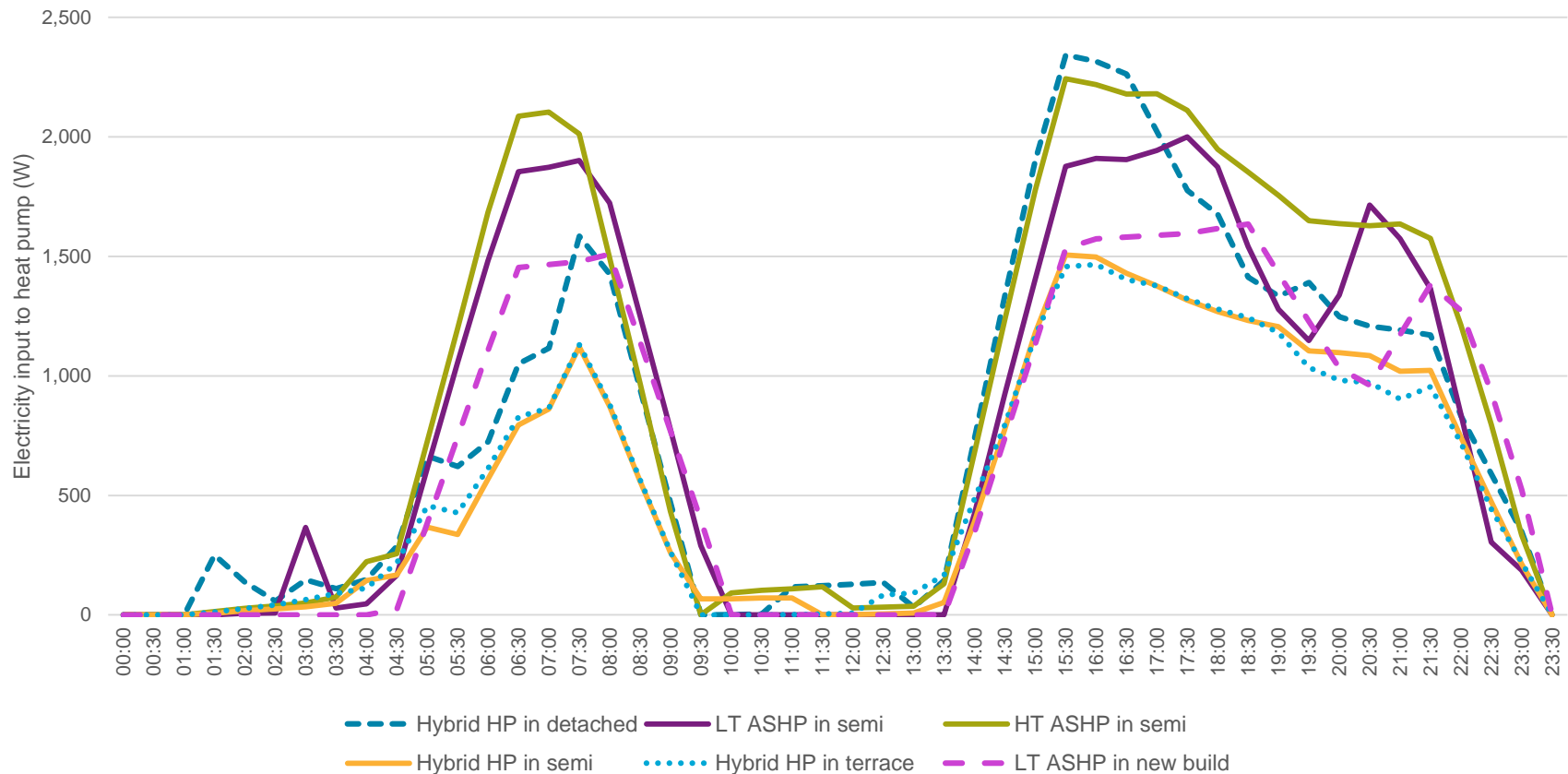

* At the LV network level, we diversify heat pump operations for low 10s of heat pumps.

Clustering of heat pump uptake on ENWL's network: distribution of heat pump uptake by feeder type used in the Transform Model*

Clustering of heat pump uptake in certain areas / feeder types could accelerate the impact of heat pump uptake on the network

- ▶ In this analysis, we have generated load profiles for different types of heat pumps in different house types on ENWL's network.
- ▶ The mix of house types in different parts of ENWL's license area will vary (e.g. in more rural areas like Cumbria, we are likely to see a higher share of large detached / semi detached dwellings, while in the more urban areas, we will see higher shares of terraced dwellings), meaning we are likely to see 'clustering' of different types of heat pump house type combinations in particular areas / on different parts of ENWL's network.
- ▶ The Transform model allows us to consider many different feeder types, and allows clustering of certain heat pump house types to these feeders.
- ▶ In the table below, we summarise the distribution ('clustering') of different heat pump house types to the different feeder types on ENWL's network.

Feeder type	Description	Hybrid in detached	Hybrid in semi	Hybrid in terrace	HT ASHP in semi	LT ASHP in semi	LT ASHP in new build
LV 1	Central business district						
LV 2	Dense urban area (apartments , high rise flats)			2%			
LV 3	Town centre			2%			
LV 4	Business park						
LV 5	Retail park						
LV 6	Suburban street (3 – 4 bed semi detached)	60%	90%		90%	55%	
LV 7	New build housing estate			6%		45%	
LV 8	Terrace street			90%			
LV 9	Rural village (overhead wires)	20%	5%		5%		
LV 10	Rural village (underground)	20%	5%		5%		
	Total	100%	100%	100%	100%	100%	

Smeared across the higher voltage level network

These are the key feeder types representing ENWL's network, so we have allocated 100% of heat pump uptake to these feeder types.

How do these assumptions differ from Transform version 5.0?

- ▶ In this study, we consider **6** different residential heat pump load profiles (versus 3 in Transform version 5.0).
- ▶ In Transform version 5.0, the uptake of the 3 heat pump types are spread in the same way, mainly across feeders LV 2, 6, 7, 8, 9, 10, with some also being allocated to the meshed network. In this study, by consider different heat pump types in different house types, we can more accurately & granularly focus uptake of the different heat pump house types to the most relevant feeder types. We also focus all uptake on the radial feeder types as ENWL has no meshed network in its region.

* See Annex C of this report for a brief description of the Transform Model

Executive Summary	4
Introduction & project scope	12
Overview of different heat pump technologies	14
▶ High level description of the different types of heat pump technologies	
▶ Technology costs, performance & 'fit' into different house types – current & future	
▶ Summary of housing stock in ENWL's region & defining the 6 heat pump – house type combinations	
High level overall methodology	22
Heat pump load profile outputs	24
▶ Methodology for developing granular & robust heat pump load profiles	
▶ Review of existing studies & projects measuring heat pump load profiles	
▶ Temperature profiles considered in this analysis & selection of outputs from our building physics modelling	
▶ Results from developing load profiles for different heat pumps in different house types	
Diversifying heat pump load profiles & clustering of heat pumps	32
▶ Overview of approach	
▶ Outputs of diversification of heat pump load profiles	
▶ Clustering assumptions for allocating different heat pump types to different LV feeder types	
Forecasting heat pump uptake rates and low-voltage distribution network impacts	44
▶ Developing the three scenarios for heat pump uptake on ENWL's network	
▶ Impact of heat pump uptake on ENWL's low-voltage distribution network – network interventions & cost of upgrading the network	
Optimisation of heat pump load profiles	69
▶ Overview of optimisation approach	
▶ Flexibility of HP operation	
▶ Outputs from Imperial's optimisation modelling – optimised load profiles	
▶ Impact of the optimised profiles on ENWL's network	
Customer side measure analysis	80
▶ Description of customer side measures & approach for assessing these measures	
▶ Analysis & quantification of reduction in the impact implementation of these measures have on ENWL's network	
Recommendations	111
Annexes	113

Three key scenarios for heat pump uptake on ENWL's network to 2050

Delta-ee has developed three scenarios for heat pump uptake on ENWL's network to 2050. These scenarios provide a wide range in the level of uptake of heat pumps on ENWL's network by 2050, enabling ENWL to understand sensitive its network is to varying levels of heat pump penetration.

The three scenarios considered are:

- ▶ Scenario 1: The 'Delta-ee reference scenario'. This is Delta-ee's reference forecast for heat pump uptake, and represents what we believe **will** happen in reality.
- ▶ Scenario 2: The 'high' scenario. This scenario aligns with the DECC high heat pump uptake rate (used in Transform), referred to as the 'DECC 1' scenario.
- ▶ Scenario 3: The 'low' scenario. This scenario aligns with the DECC low heat pump uptake rate (used in Transform), referred to as the 'DECC 4' scenario.

Comparison of heat pump uptake under the three scenarios

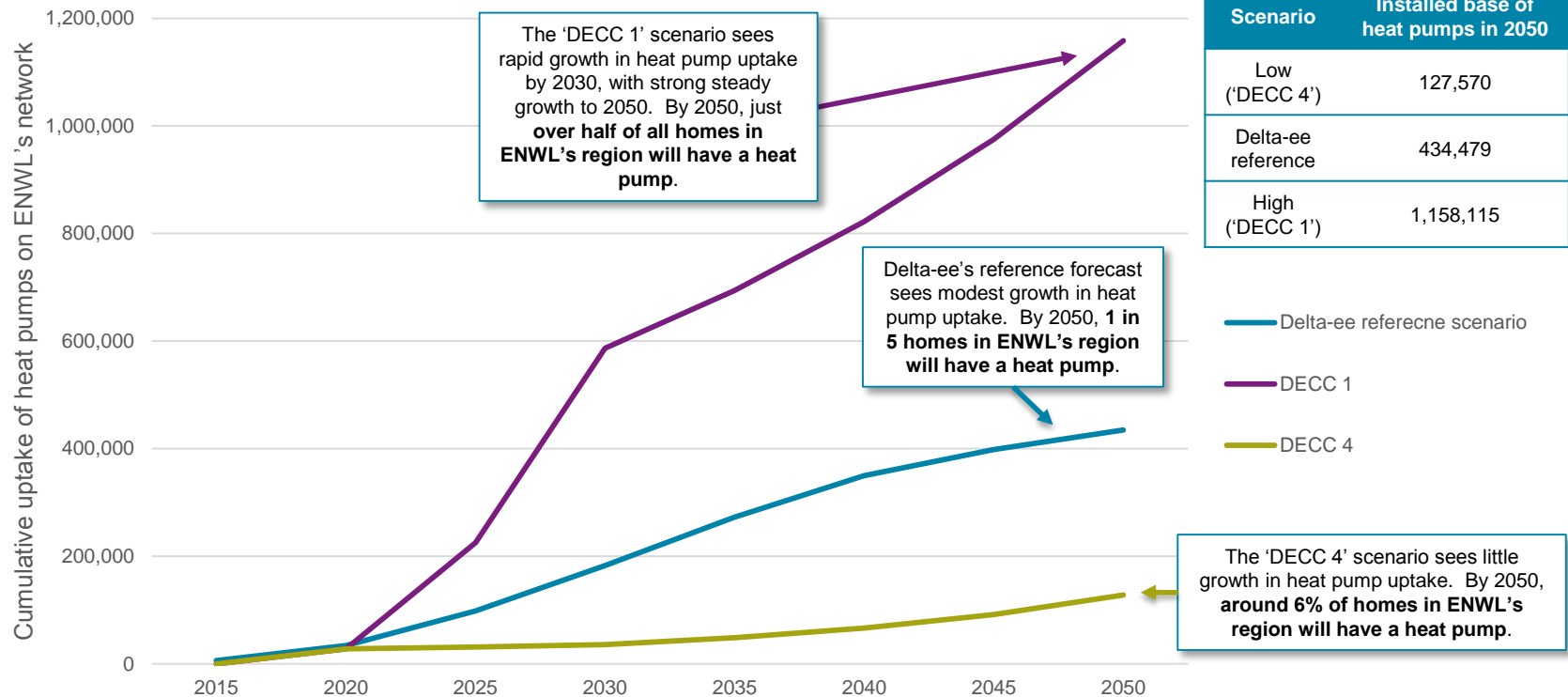

Reference scenario: Four key pillars that shape our reference view

Below, we provide a short summary of the key factors that shape and influence our reference forecast. For each 'key pillars' we develop a set of assumptions that feed into the Delta-ee Pathways Tool to generate our heat pump forecast to 2050.

Policy

'Electrification of heat' ambition remains, but is delayed

- ▶ Renewable Heat Incentive reduces gradually in the next few years to 2020, and disappears completely by 2026.
- ▶ New build regulations do not tighten until 2021/22, at which point ASHPs become the base case in off-gas dwellings. Gas boilers are banned from new builds in 2030 to accelerate uptake of heat pumps post 2030.
- ▶ Insulation in retrofit is the 'low cost' option that policy makers focus on for savings energy and reducing carbon emissions.
- ▶ 2020 RE & carbon targets are missed. Commitment to hitting 2050 targets remains, but are only met close to 2050.

Slow growth in heat pump sales results in gradual cost reductions

- ▶ Heat pump manufacturer and boiler makers continue to offer HP solutions and gradually add hybrids to their portfolio.
- ▶ Fully installed prices still fall quickly in the short term as installer skill improves, but more slowly in the longer term as uptake post 2020 is low.
- ▶ Efficiency still gradually improves due to technology performance improvements coming from Asia / Germany, and as system design, insulation levels of buildings and lower temperature heat distribution systems become more common.

Technology

Customers and installers

Customer awareness remains low until 2020 with installers favouring low cost gas boilers until 2025

- ▶ No real change in customer awareness & attitude until 2020 at which point building regulations drive the awareness and trust in heat pump technology.
- ▶ Customer confidence in policy / incentives for 'low carbon' remains low following a sharp reduction in FiT for PV and a small reduction in the RHI in 2016.
- ▶ Installers remain cautious about investment in training to install heat pump technologies, and continue to focus on offering customers boilers until 2020 - 2025.

Appliance manufacturers gradually add new product to their portfolios by 2020, with electricity suppliers getting more active post 2020

- ▶ Boiler manufacturers are slow to add new heat pump products to their portfolio (except for Ideal via Atlantic), especially after the poor uptake of hybrid heat pumps experienced in 2014/15.
- ▶ Heat pump manufacturers continue to introduce more product to the UK, but are more cautious about the opportunity in the UK market following revisions in the RHI.
- ▶ Electricity suppliers introduce heat pump electricity tariffs post 2020 to help stimulate uptake of HPs.

Industry 'push'

Approach to developing the 'high' and 'low' scenario heat pump uptake rates

After building its reference forecast for heat pump uptake, Delta-ee edited some of the key assumptions behind its modelling to scale up, and down, the reference forecast to align with the 'DECC 1' and 'DECC 4' scenarios respectively. On the following slide, we summarise the differences in assumptions between the three scenarios.

Key differences between our 3 scenarios

Significant factors influencing heat pump uptake that vary across our 3 scenarios are:

- ▶ Level of **RHI support** available for heat pumps.
- ▶ **Building regulations** for new build dwellings & for existing buildings – influencing the choice of technologies being installed in new builds or used to replace conventional heating appliances in existing buildings.
- ▶ The introduction and level of **heat pump specific electricity tariffs**.

Level of RHI tariff (p / kWh) for ASHPs across the three scenarios (note - the heat pump portion of hybrids also receives this incentive)

Scenario	2015	2020	2025	2030	2050
Low ('DECC 4')	7.42	1.76	0	0	0
Reference	7.42	6.54	3.86	0	0
High ('DECC 1')	7.42	6.54	5.76	2.88	0.7

Summary of building regulations across the three scenarios

Scenario	2015	2020	2025	2030	2050
Low ('DECC 4')	Condensing gas & electric storage heaters are base case in new build.	No change.	No change.	From 2030: ASHP is base case in off gas new builds; boiler plus PV is base case in on gas new builds.	No change.
Reference	Condensing gas & electric storage heaters are base case in new build.	From 2021: ASHP is base case in off gas new builds; boiler plus PV base case in on gas new builds.	50% fewer 'gas' new builds (push towards electric)	75% fewer 'gas' new builds (push towards electric).	No 'gas' new build post 2030.
High ('DECC 1')	Condensing gas & electric storage heaters are base case in new build.	From 2021: ASHP is base case in off gas new builds; boiler plus PV base case in on gas new builds.	50% fewer 'gas' new builds (push towards electric)	75% fewer 'gas' new builds (push towards electric). Oil replacements banned from 2030 – ASHP required instead.	No 'gas' new build post 2030.

Heat pump specific electricity tariff levels across the three scenarios

Scenario	2015	2020	2025	2030	2050
Low ('DECC 4')	None	None	None	None	None
Reference	None	None	80% of retail price from 2025	50% of retail price from 2030	No change
High ('DECC 1')	None	80% of retail price from 2018	60% of retail price from 2025	45% of retail price from 2030	No change

Delta-ee Reference Scenario forecast for heat pump uptake ANNUAL SALES in ENWL's region

Modest growth in sales to 2020, with new regulations boosting the market post 2020.

- ▶ ASHPs dominate sales in the near term with hybrids gaining significant market share by 2030.
- ▶ High temperature ASHP sales stay flat while low temperature ASHPs sales grow quickly. Low temperature ASHPs are only now arriving on the UK market and uptake will be driven by new build regulations post 2020.
- ▶ Hybrids are yet to gain a foothold in the UK market due to limited product availability and weak economic propositions. Lower cost low capacity options will see good growth in terrace / semi detached dwellings.

Annual sales of heat pumps in ENWL's region – Reference scenario

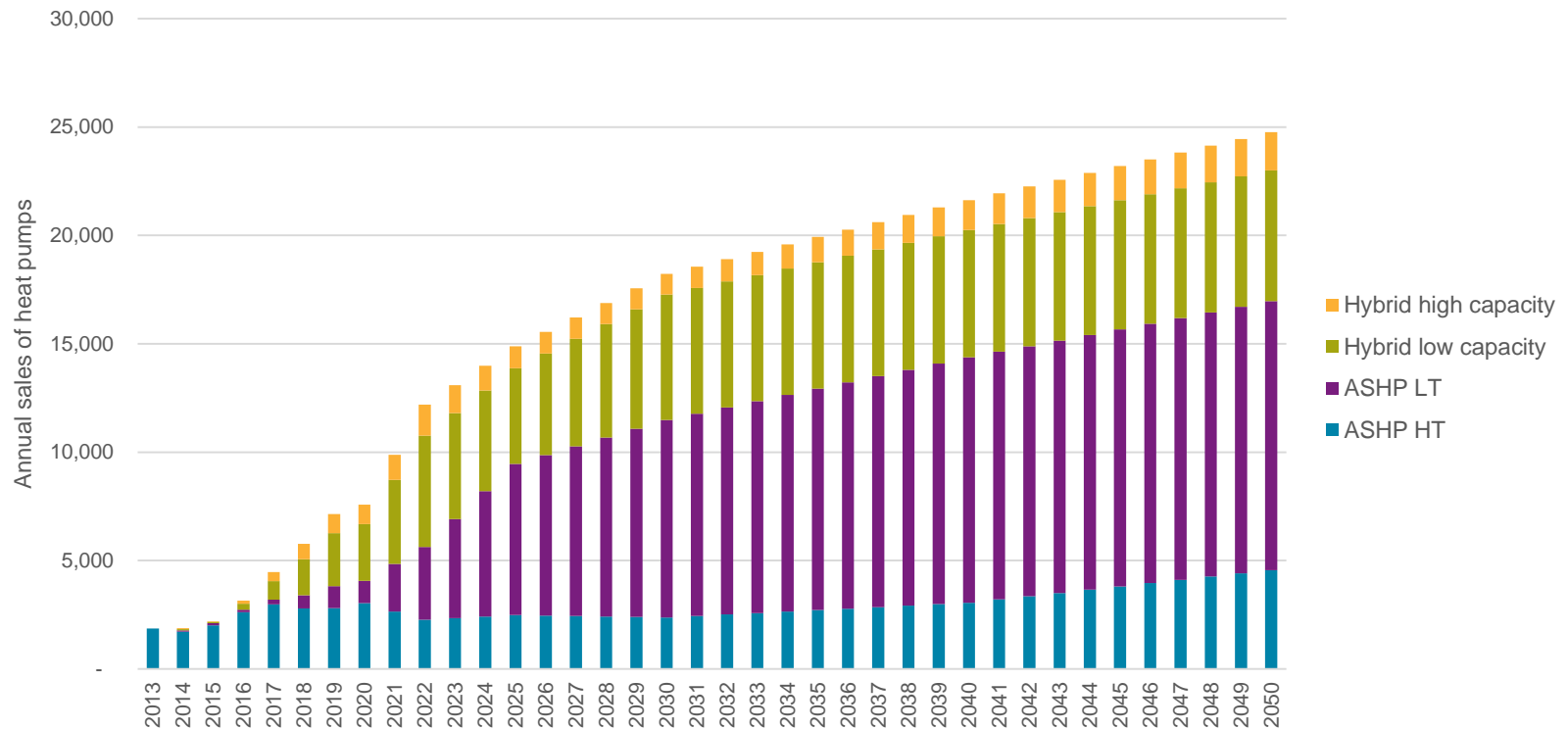

Delta-ee Reference Scenario forecast for heat pump Cumulative UPTAKE in ENWL's region

By 2025, we see close to 100,000 heat pump solutions being connected to ENWL's network. This grows to ~430,000 units by 2050

- ▶ Pure electric ASHPs will account for just over half of the heat pumps connected to ENWL's network by 2025, with high temperature systems still accounting for the majority of this. ASHPs account for two thirds of systems connected by 2050.

Installed base of heat pumps in ENWL's region – Reference scenario

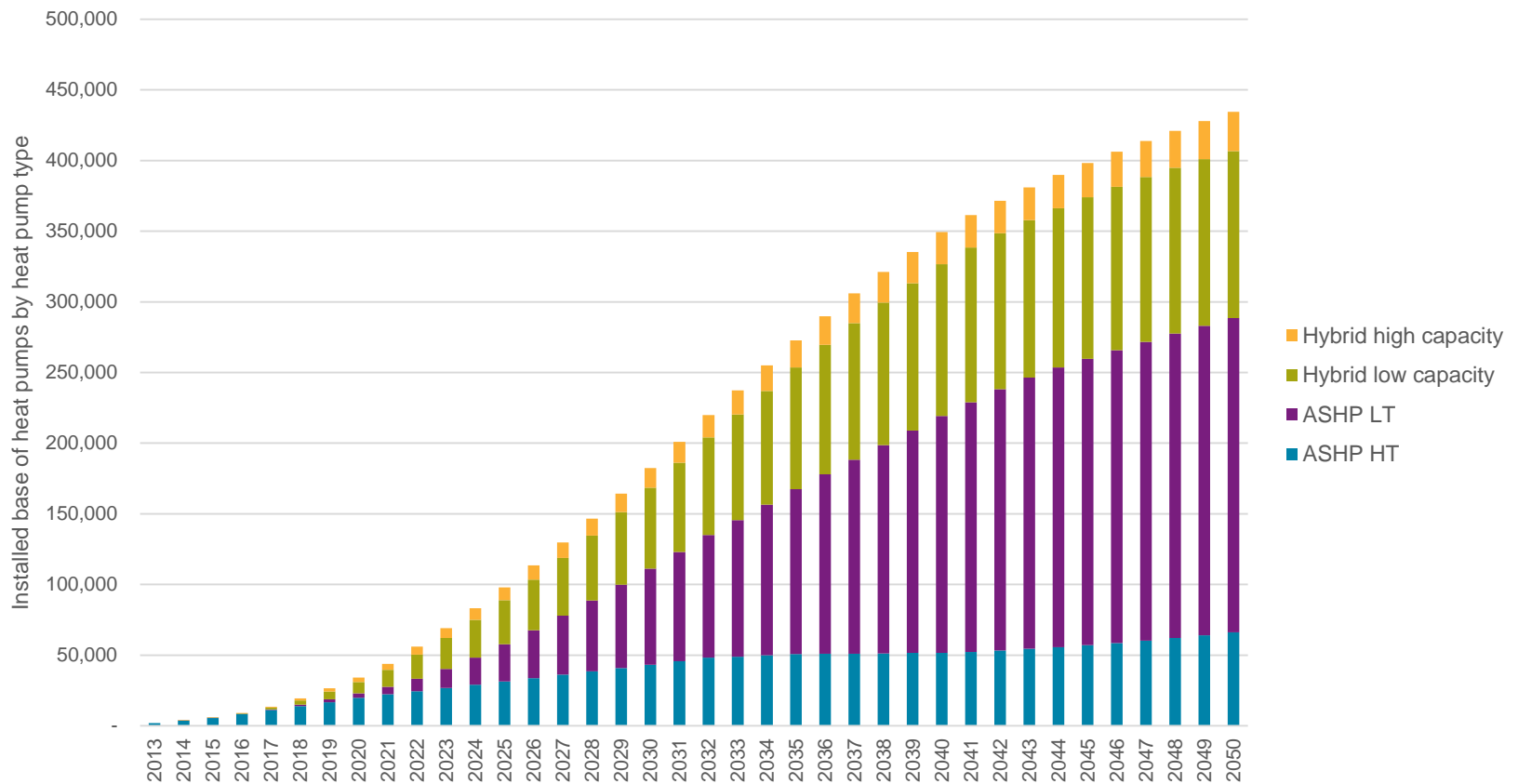

'DECC 4' (Low) scenario forecast for heat pump ANNUAL SALES in ENWL's region

Almost no growth in sales to 2025, with new regulations boosting the market post 2030. Sales reach ~11,000 units / yr by 2050.

- ▶ ASHPs dominate sales to 2030 at which point low cost hybrids start to gain market share.
- ▶ High temperature ASHP sales stay flat while low temperature ASHPs sales grow quickly from 2025 onwards (driven by new build regulations post 2025).
- ▶ Only low cost low capacity hybrids gain a significant share of the market by 2050 – supported by building regulations.

Annual sales of heat pumps in ENWL's region - Low scenario

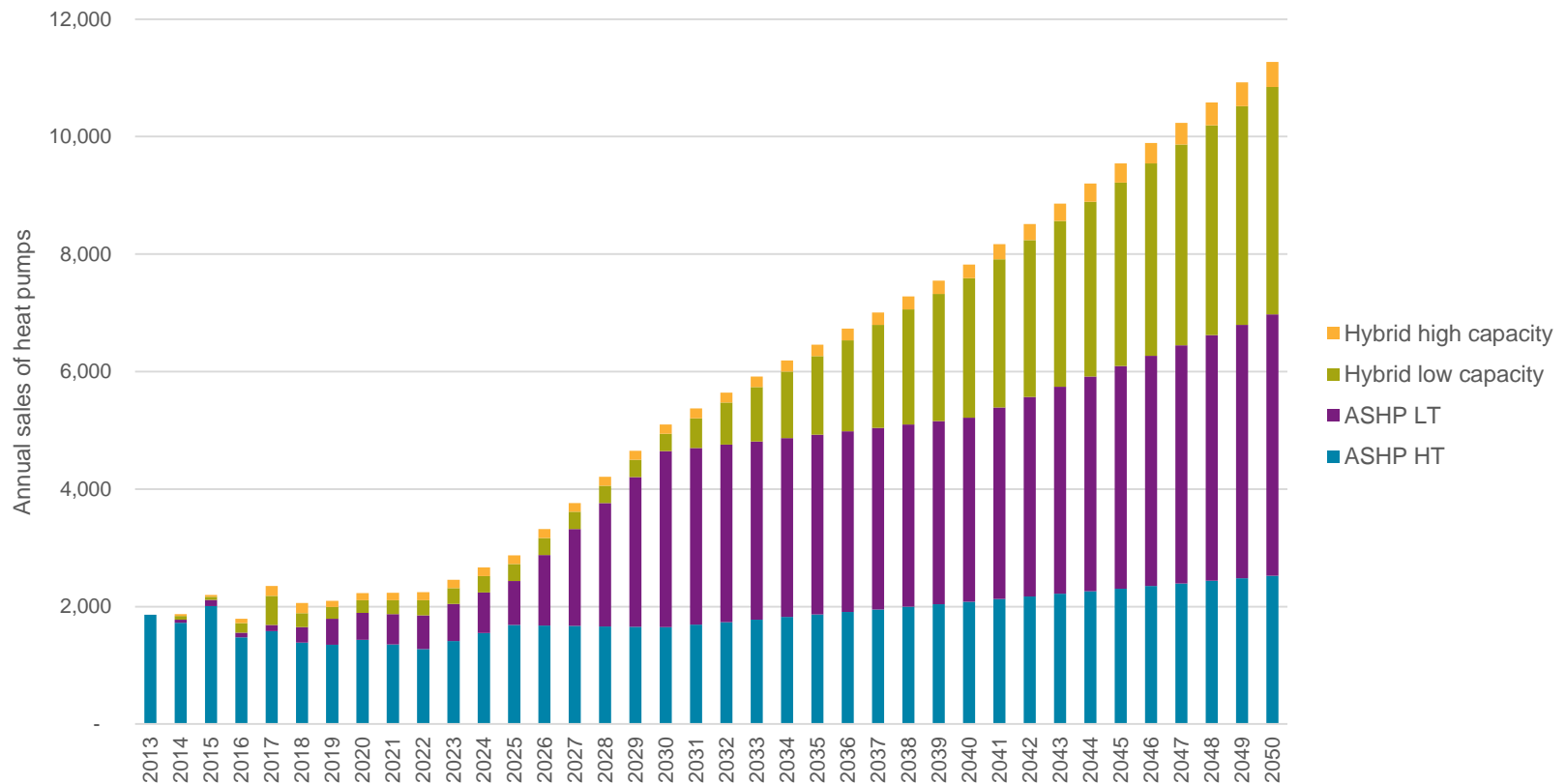

'DECC 4' ('Low') scenario forecast for heat pump Cumulative UPTAKE in ENWL's region

We see little growth in the number of heat pump solutions being connected to ENWL's network to 2030, with modest growth occurring towards 2050. The installed base reaches ~130,000 units by 2050.

- ▶ Pure electric ASHPs will dominate the sales and installed base of heat pumps connected to ENWL's network to 2050, with low temperature systems accounting for the majority of this.
- ▶ Hybrid heat pump installations will see a very slow and small growth in penetration to 2050.

Installed base of heat pumps in ENWL's region – Low scenario

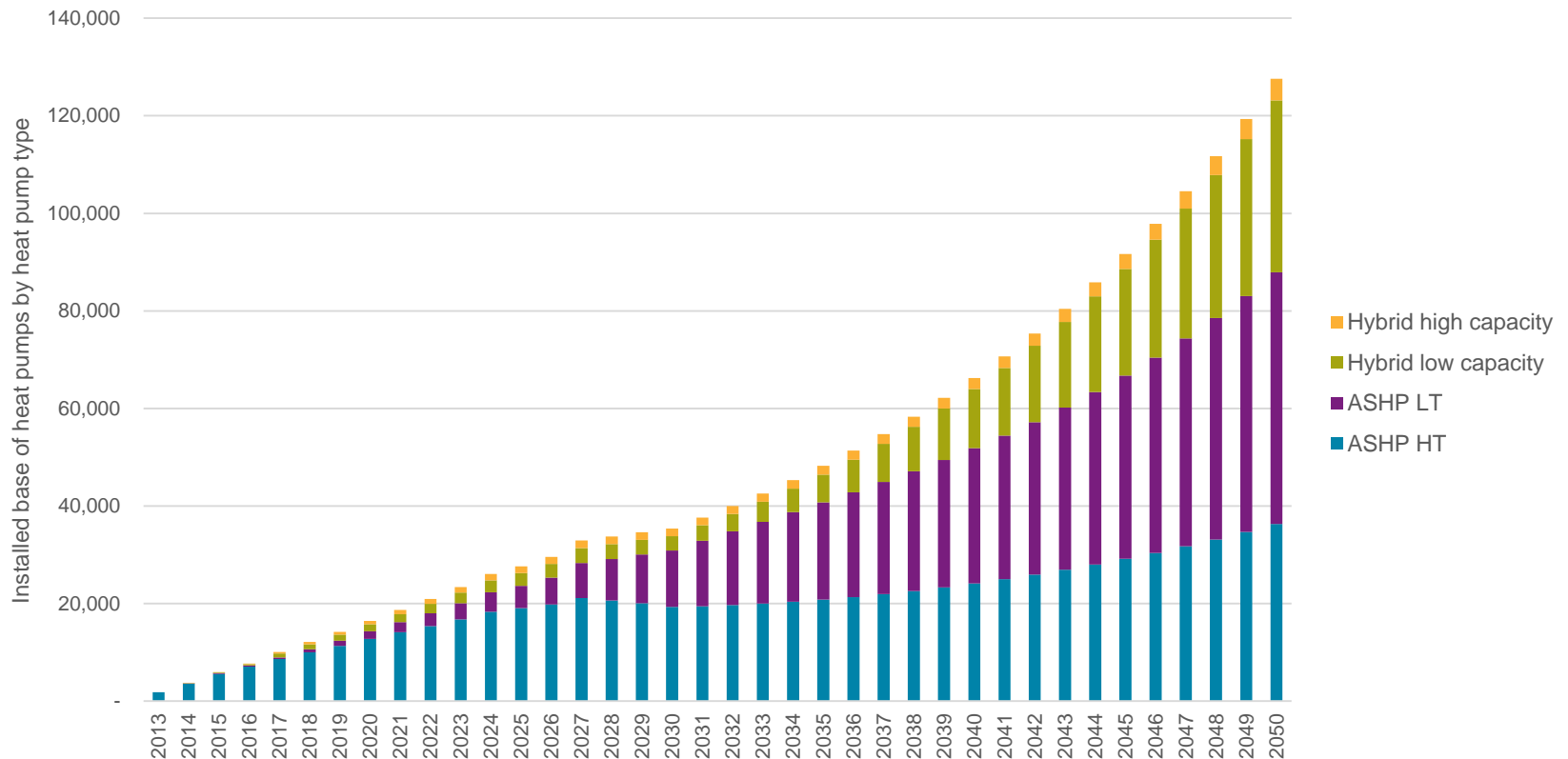

'DECC 1' (High) scenario forecast for heat pump ANNUAL SALES in ENWL's region

Explosive growth in sales between 2020 and 2030, leading to annual sales of 60,000 units per year in 2050.

- ▶ ASHPs dominate sales in the very near term with hybrids gaining an equal market share from ~2030 onwards.
- ▶ High temperature ASHP sales see modest growth while low temperature ASHPs sales grow quickly from 2020 – driven by building regulations.
- ▶ Hybrids see a slow and steady growth in sales from ~2017 onwards, and rival sales of ASHPs from 2030. Low cost low capacity hybrids dominate.

Annual sales of heat pumps in ENWL's region - High scenario

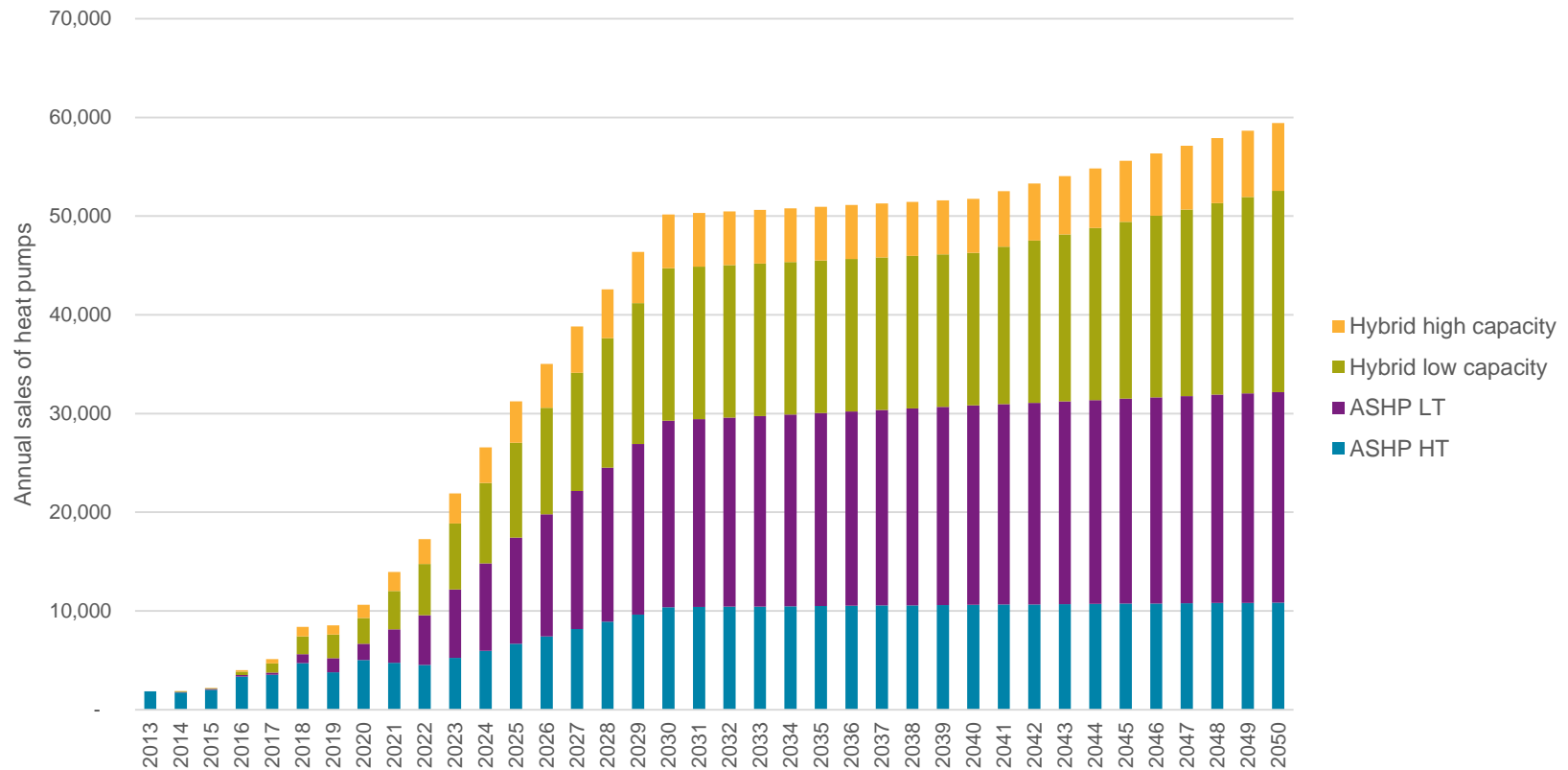

'DECC 1' (High) scenario forecast for heat pump Cumulative UPTAKE in ENWL's region

By 2025, we see over 200,000 heat pump solutions being connected to ENWL's network, growing to 600,000 in 2030 and 1.1 million by 2050.

- ▶ Pure electric ASHPs will account for just over half of the heat pumps connected to ENWL's network by 2025, with high temperature systems still accounting for the majority of this.
- ▶ In the 2030 to 2050 period, ASHPs and hybrids will each account for ~50% of installations.

Installed base of heat pumps in ENWL's region – High scenario

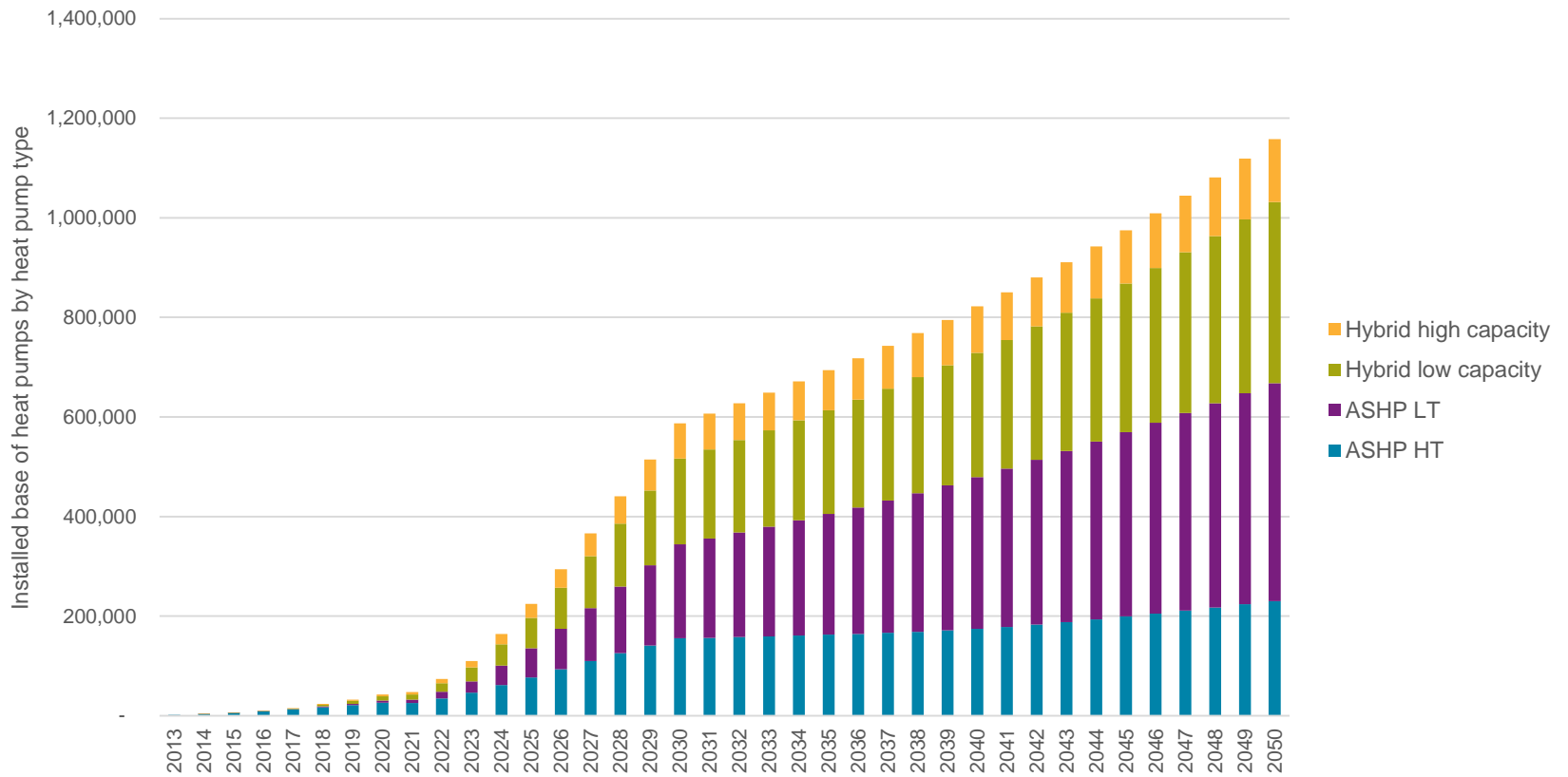

Commercial scale heat pump uptake rates Cumulative UPTAKE in ENWL's region

Below, we illustrate the uptake rates of commercial scale heat pumps under the 'DECC 1' (High), 'DECC 4' (Low) and 'DECC 2' (Reference) scenarios. Delta-ee has used DECC's forecasted uptake rates as used in EA Technology's Transform v5.0 model for this analysis.

- ▶ Across all three scenarios, we see modest uptake of commercial scale heat pumps in ENWL's region by 2050, which Delta-ee believes is possible by 2050.
- ▶ Under the low scenario, the installed base reaches ~20,000 by 2050, while under the high scenario, the installed base reaches ~33,000.
- ▶ Delta-ee believes that this range of 20,000 – 33,000 commercial scale heat pumps in ENWL's region by 2050 is possible, and uses the 'DECC 2' uptake rate (of ~25,000 by 2050) in its reference scenario analysis.
- ▶ The commercial scale heat pumps modelled in Transform v5.0 have a peak electricity demand of ~12 kW (this equivalent to around 30 – 40 kW thermal output). For comparison, the residential scale heat pumps we have modelled in this study have a thermal output of 5 – 8kW.

Commercial scale heat pump uptake in ENWL's region under difference scenarios

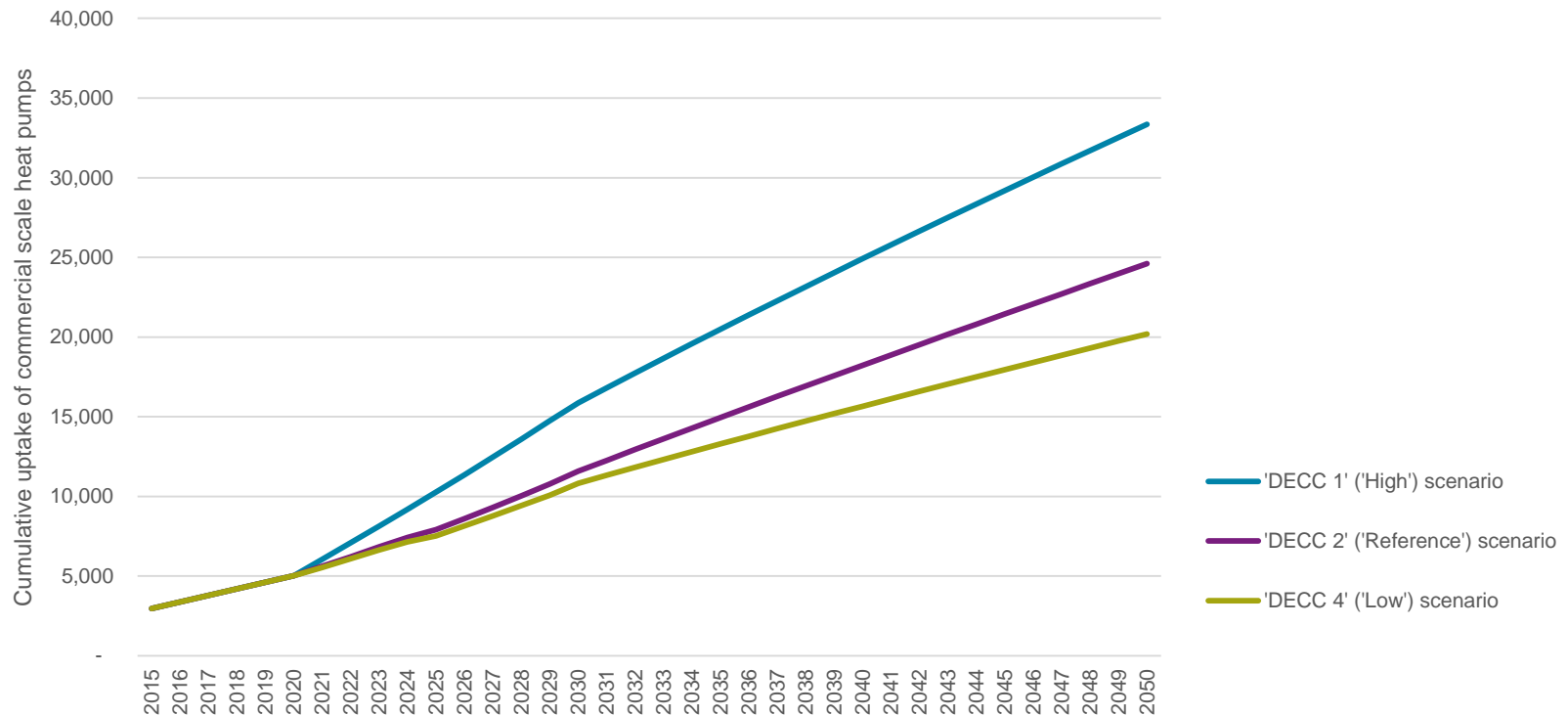

Impact on ENWL's low-voltage distribution network of heat pump uptake under the 3 scenarios: assuming a '1 in 20' peak winter

The impact of heat pump uptake (assuming the un-optimised diversified heat pump load profiles) on ENWL's low-voltage distribution network to 2050 will be significant under the reference and high scenarios during a 1 in 20 peak winter day.

- Under the high and reference scenarios for heat pump uptake in ENWL's region, significant numbers of network interventions will be required to facilitate this uptake, if ENWL plans its network for a '1 in 20' peak winter day.
- Under the high scenario, significant amounts of underground works are required (which offsets the need for some lower cost upgrades to transformers) while under the reference scenario, we see similar amounts of transformer upgrades & groundworks being required.
- The high scenario sees around two third* of ENWL's transformers to be upgraded by 2050. The reference scenario sees just over 10% being upgraded.
- See Annex E for a detailed description of the network 'interventions' mentioned below, and on the slides throughout this report.

Results for a '1 in 20' peak day

Number of interventions at the low-voltage network level under all three scenario:

'1 in 20' winter peak

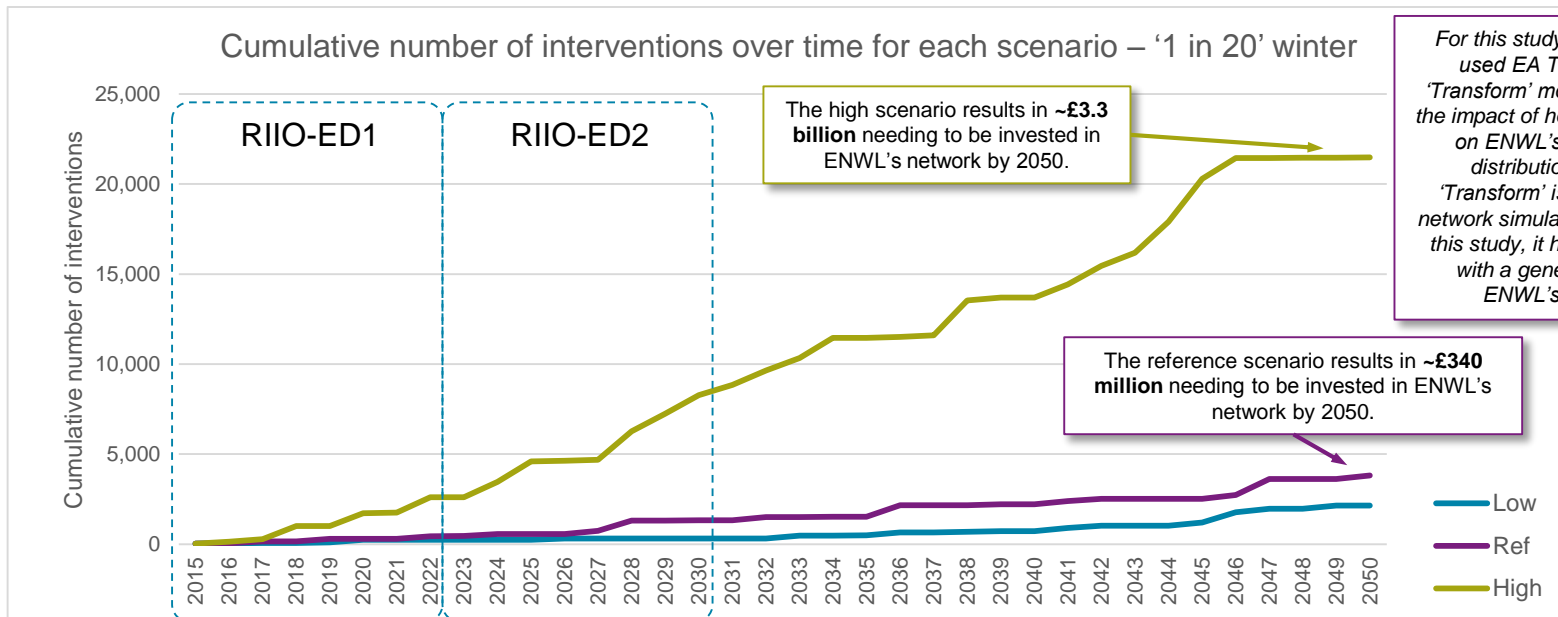

	Low	Reference	High
Cumulative number of LV network 'interventions' by 2050 per scenario	2,145	3,808	21,482
LV transformer upgrades (ground mounted & pole mounted)	1,346	1,754	6,607
LV underground works (major & minor)	799	2,054	14,865
Other	0	0	10

Note – the major & minor 'LV underground works' include the installation of new transformers

* Based on ENWL having around 34,000 transformers & ~70,000 feeders at the LV network level

Impact on ENWL's low-voltage distribution network of heat pump uptake under the 3 scenarios: assuming an 'average' peak winter day

The impact of heat pump uptake (assuming the un-optimised diversified heat pump load profiles) on ENWL's low-voltage distribution network to 2050 will be significant under the high scenario & modest under the reference scenario during an 'average' winter.

- Under the high scenario for heat pump uptake in ENWL's region, significant numbers of network interventions will be required to facilitate this uptake. In the reference scenario, ~2,400 interventions are required, if ENWL plans for an 'average' peak winter to 2050.
- Under the high scenario, significant amounts of underground works & transformer upgrades are required while under the reference scenario, we see more transformer upgrades being required, but less groundworks.
- The high scenario sees around one third* of ENWL's transformers to be upgraded by 2050. The reference scenario sees ~5% to 10% being upgraded.
- See Annex E for a detailed description of the network 'interventions' mentioned below, and on the slides throughout this report.

Results for an 'average' peak day

Number of interventions at the low-voltage network level under all three scenario:

'Average' winter peak

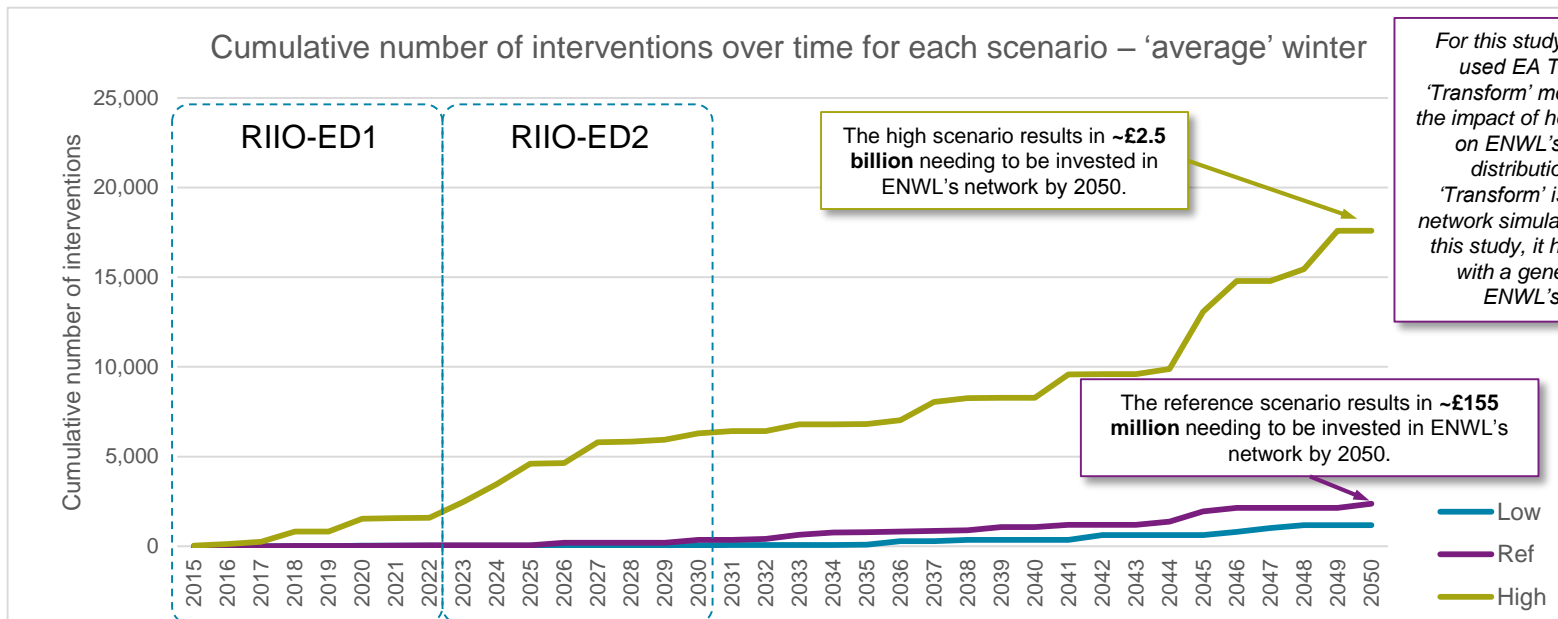

For this study, Delta-ee has used EA Technology's 'Transform' model to simulate the impact of heat pump uptake on ENWL's low-voltage distribution network. 'Transform' is an electricity network simulation tool, and for this study, it has been set up with a generic model of ENWL's network.

The reference scenario results in ~£155 million needing to be invested in ENWL's network by 2050.

The high scenario results in ~£2.5 billion needing to be invested in ENWL's network by 2050.

	Low	Reference	High
Cumulative number of LV network 'interventions' by 2050 per scenario	1,175	2,373	17,594
LV transformer upgrades (ground mounted & pole mounted)	1,175	1,574	8,454
LV underground works (major & minor)	0	799	9,130
Other	0	0	10

Note – the major & minor 'LV underground works' include the installation of new transformers

* Based on ENWL having around 34,000 transformers & ~70,000 feeders at the LV network level

Impact on ENWL's LV network of heat pump uptake under the 3 scenarios: Number of 'network interventions' & investment cost – reference scenario

Significant investments in ENWL's low-voltage network will be required by 2050 to support the reference scenario uptake of heat pumps, if ENWL plans its network for a '1 in 20' winter.

- Under the reference scenario, we see ~50 interventions per year being required in ED1 during a '1 in 20' winter, with the number of interventions doubling to ~100 per year during ED2.
- By 2050, around £340 million will need to be invested in ENWL's network.
- Total network costs below are based on cost assumptions in Transform Version 5.0 from EATL. See annex for detailed assumptions.

Heat pump uptake under the reference scenario:
430,000 by 2050

Number of interventions required on the LV network per 4 year period

'1 in 20' winter peak

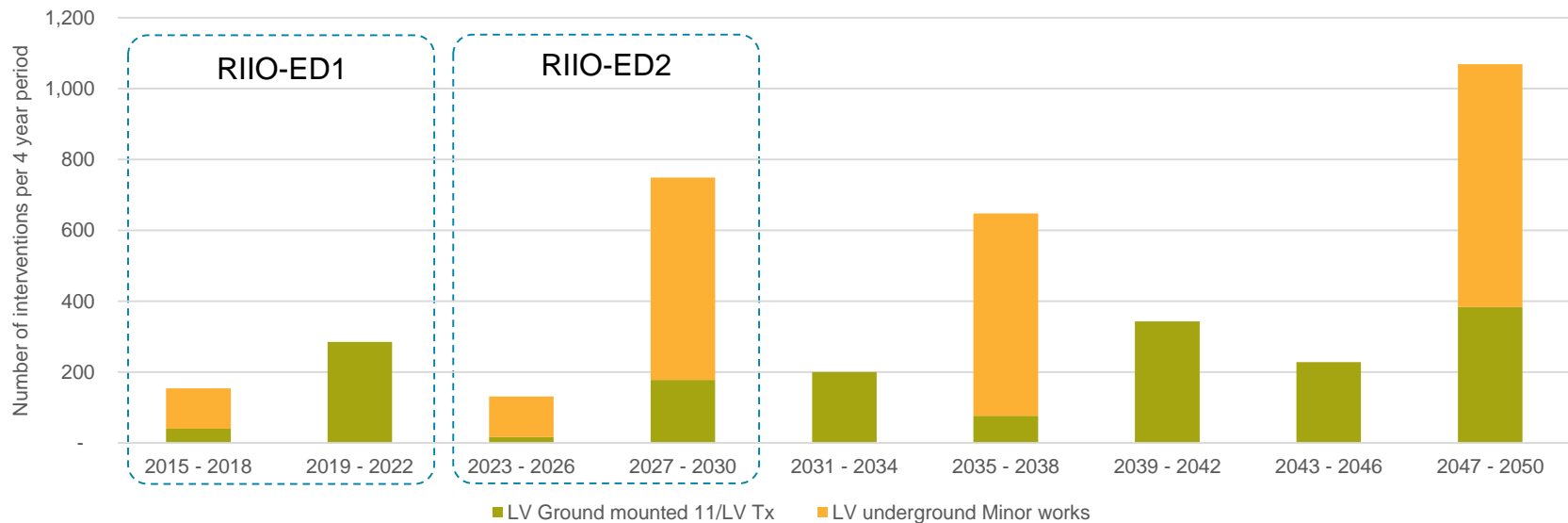

	2022	2030	2050
<i>Cumulative number of interventions required by end of time period</i>	439	1,320	3,808
Cumulative costs associated with LV Ground mounted upgrades (£ millions)	6.0	9.8	35.7
Cumulative costs associated with LV underground minor works (£ millions)	15.0	111.5	303.5
Total (£ millions)	21.0	121.3	339.2

Impact on ENWL's LV network of heat pump uptake under the 3 scenarios: Investment cost in ENWL's network by feeder type – reference scenario

If ENWL plans for a '1 in 20' winter, significant investments will be required in suburban (3 – 4 bed semi) by 2050, with modest investments required in the short term.

- Under the reference scenario, significant investment will be required during ED2 in feeders serving suburban areas (with large proportions of semi detached & detached dwellings).
- Further significant investment in suburban feeders will be needed during the 2030s and 2040s, with small investments being required in more urban areas where feeders are serving terraced dwellings closer to 2050.
- Total network costs below are based on cost assumptions in Transform Version 5.0 from EATL. See annex for detailed assumptions.

Heat pump uptake under the reference scenario:
430,000 by 2050

Investment required per 4 year period to 2050 per feeder type

'1 in 20' winter peak

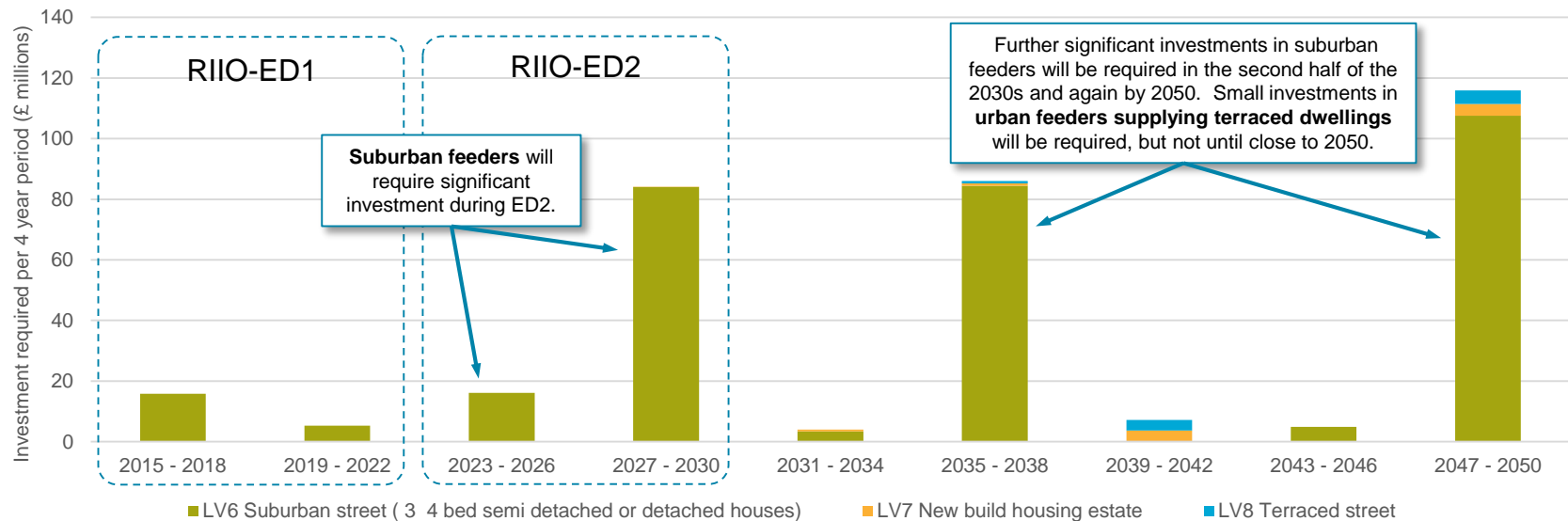

	2022	2030	2050
Cumulative costs associated with LV 6 suburban street (£ millions)	21.0	121.2	321.4
Cumulative costs associated with LV 7 new build housing estate (£ millions)	0	0.1	9.1
Cumulative costs associated with LV 8 terraced street (£ millions)	0	0	8.7
Total (£ millions)	21.0	121.3	339.2

Impact on ENWL's LV network of heat pump uptake under the 3 scenarios: Number of 'network interventions' & investment cost – reference scenario

Significant investments in ENWL's low-voltage network will be required by 2050 to support the reference scenario uptake of heat pumps, if ENWL plans its network for an 'average' winter.

- Under the reference scenario, we see only ~10 interventions per year being required in ED1 during an 'average' peak winter. This grows slightly to 30 – 50 interventions per year during ED2, and grows significantly after 2030 to 50 – 100s of interventions per year.
- By 2050, around £150 million will need to be invested in ENWL's network.
- Total network costs below are based on cost assumptions in Transform Version 5.0 from EATL. See annex for detailed assumptions.

Heat pump uptake under the reference scenario:
430,000 by 2050

Number of interventions required on the LV network per 4 year period

'Average' winter peak

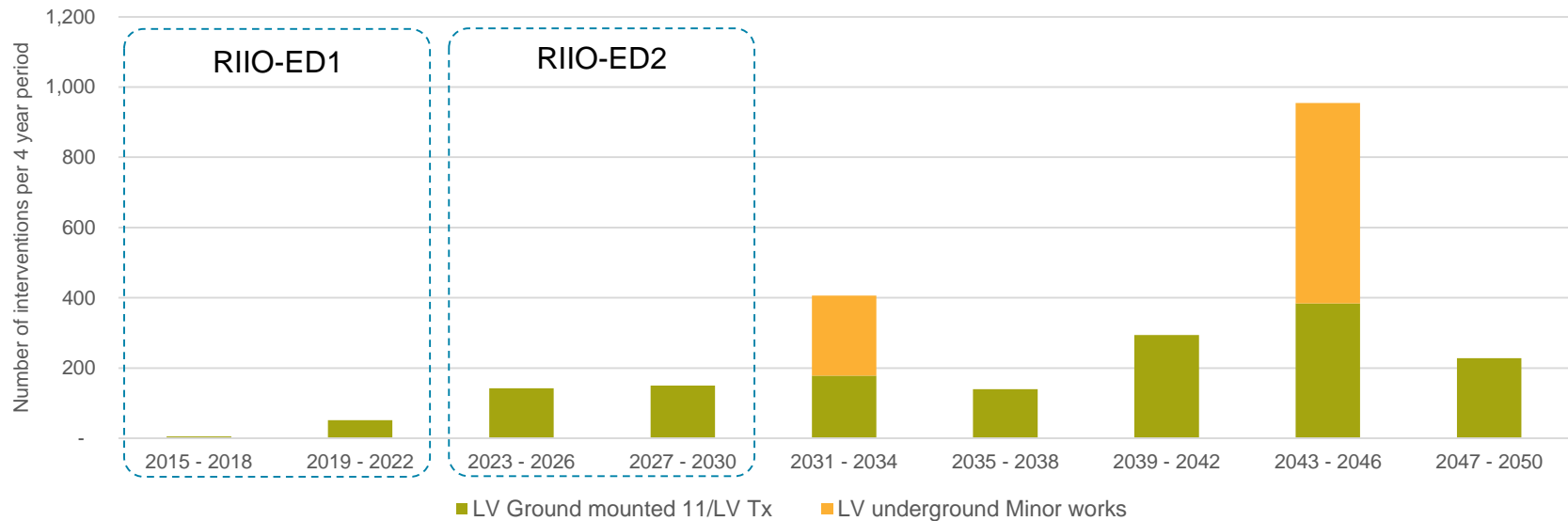

	2022	2030	2050
<i>Cumulative number of interventions required by end of time period</i>	57	350	2,373
Cumulative costs associated with LV Ground mounted upgrades (£ millions)	1.1	6.7	32.4
Cumulative costs associated with LV underground minor works (£ millions)	0	0	122.0
Total (£ millions)	1.1	6.7	154.4

Impact on ENWL's LV network of heat pump uptake under the 3 scenarios: Investment cost in ENWL's network by feeder type – reference scenario

If ENWL plans for an 'average' winter, modest investments will be required in suburban (3 – 4 bed semi) feeders by 2050, with very little investment required before 2030.

- Under the reference scenario, significant investment will be required during ED2 in feeders serving suburban areas (with large proportions of semi detached & detached dwellings).
- From 2035 onwards, significant investments are required in more urban areas where feeders are serving terraced dwellings.
- Total network costs below are based on cost assumptions in Transform Version 5.0 from EATL. See annex for detailed assumptions.

Heat pump uptake under the reference scenario:
430,000 by 2050

Investment required per 4 year period to 2050 per feeder type

‘Average’ winter peak

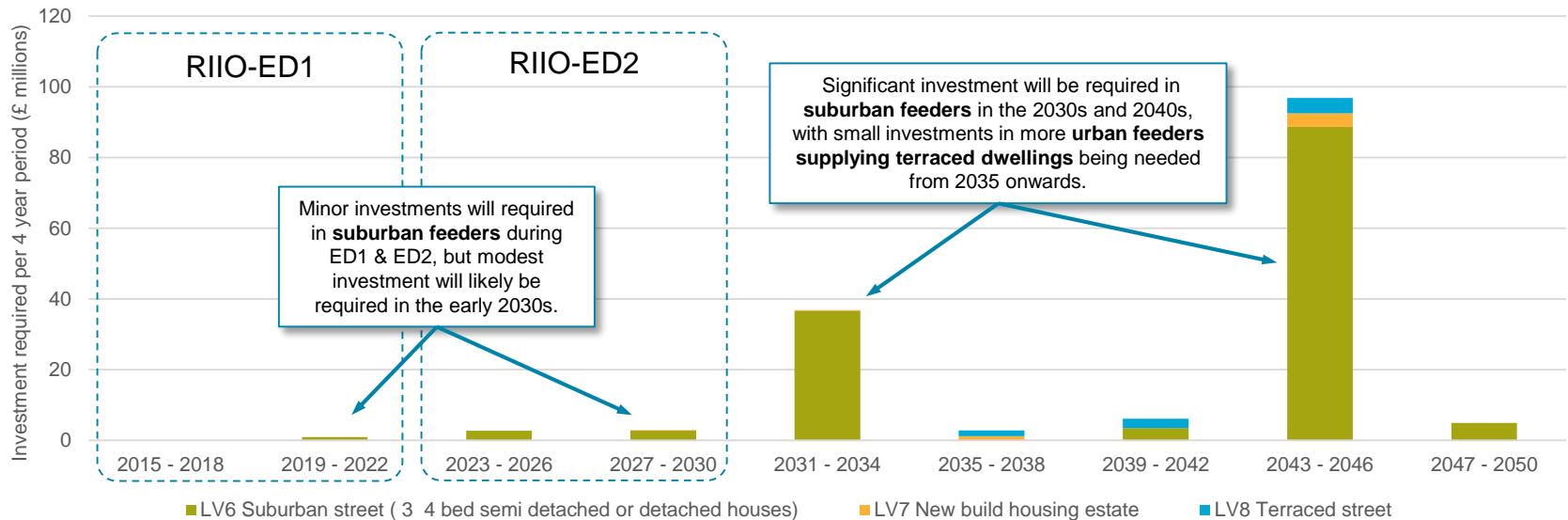

	2022	2030	2050
Cumulative costs associated with LV 6 suburban street (£ millions)	1.1	6.6	140.5
Cumulative costs associated with LV 7 new build housing estate (£ millions)	0	0.1	5.3
Cumulative costs associated with LV 8 terraced street (£ millions)	0	0	8.6
Total (£ millions)	1.1	6.7	154.4

Impact on ENWL's LV network of heat pump uptake under the 3 scenarios: Number of 'network interventions' & investment cost – high scenario

Huge investments in ENWL's low-voltage network will be required by 2050 to support the high scenario uptake of heat pumps if ENWL plans its network for a '1 in 20' winter.

- Under the high scenario, we see ~300 interventions per year required in ED1, growing to 700 per year during ED2.
- By 2050, more than £3 billion will need to be invested in ENWL's network.
- Total network costs below are based on cost assumptions in Transform Version 5.0 from EATL. See annex for detailed assumptions.

Heat pump uptake under the high scenario:
1.15 million by 2050

Number of interventions required on the LV network per 4 year period

'1 in 20' winter peak

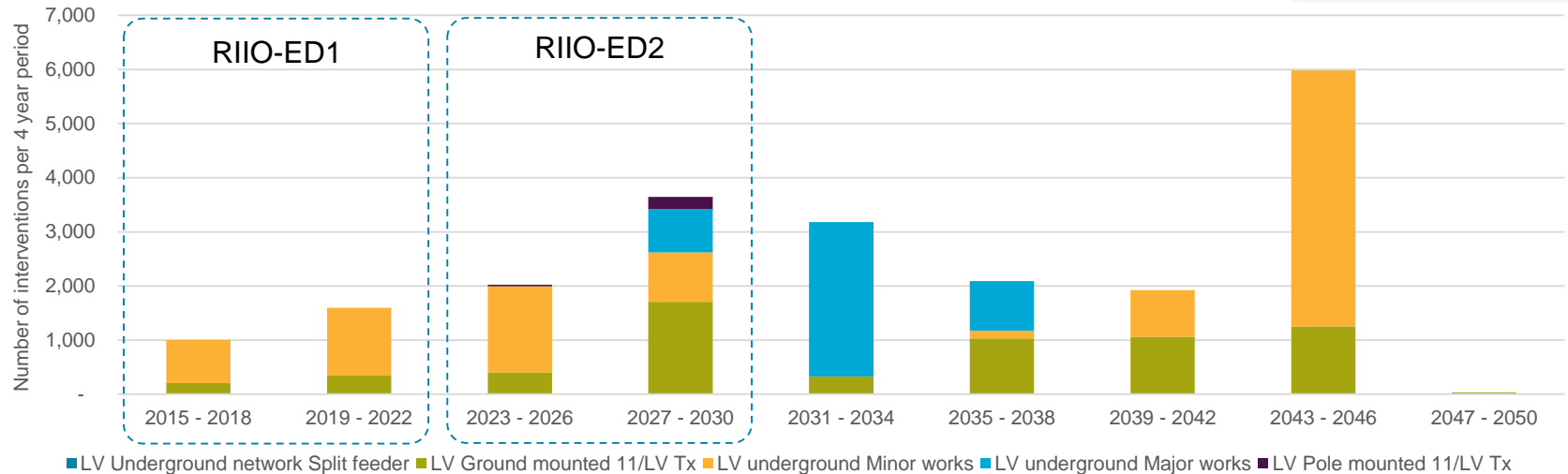

	2022	2030	2050
<i>Cumulative number of interventions required by end of time period</i>	2,604	8,273	21,482
Cumulative costs associated with LV Ground mounted upgrades (£ millions)	10.2	51.1	118.4
Cumulative costs associated with LV underground minor works (£ millions)	276.4	627.0	1,512.4
Cumulative costs associated with LV underground major works (£ millions)	0	285.2	1,663.1
Cumulative costs associated with LV pole mounted upgrades (£ millions)	0	2.1	2.1
Cumulative costs associated with LV underground network split feeder works (£ millions)	0	0	0.5
Total	286.6	965.4	3,306.5

Impact on ENWL's LV network of heat pump uptake under the 3 scenarios: Investment cost in ENWL's network by feeder type – high scenario

Huge investments will be required in suburban feeders by 2030, and through to 2040. New build estate feeders will require modest investments closer to 2050.

- Under the high scenario, significant investment will be required during ED1, ED2 & during the 2030s in feeders serving suburban areas (with large proportions of semi detached & detached dwellings).
- From 2040 onwards, significant investments are required in feeders serving recently built new build housing estates.
- Total network costs below are based on cost assumptions in Transform Version 5.0 from EATL. See annex for detailed assumptions.

Heat pump uptake under the high scenario:
1.15 million by 2050

‘1 in 20’ winter peak

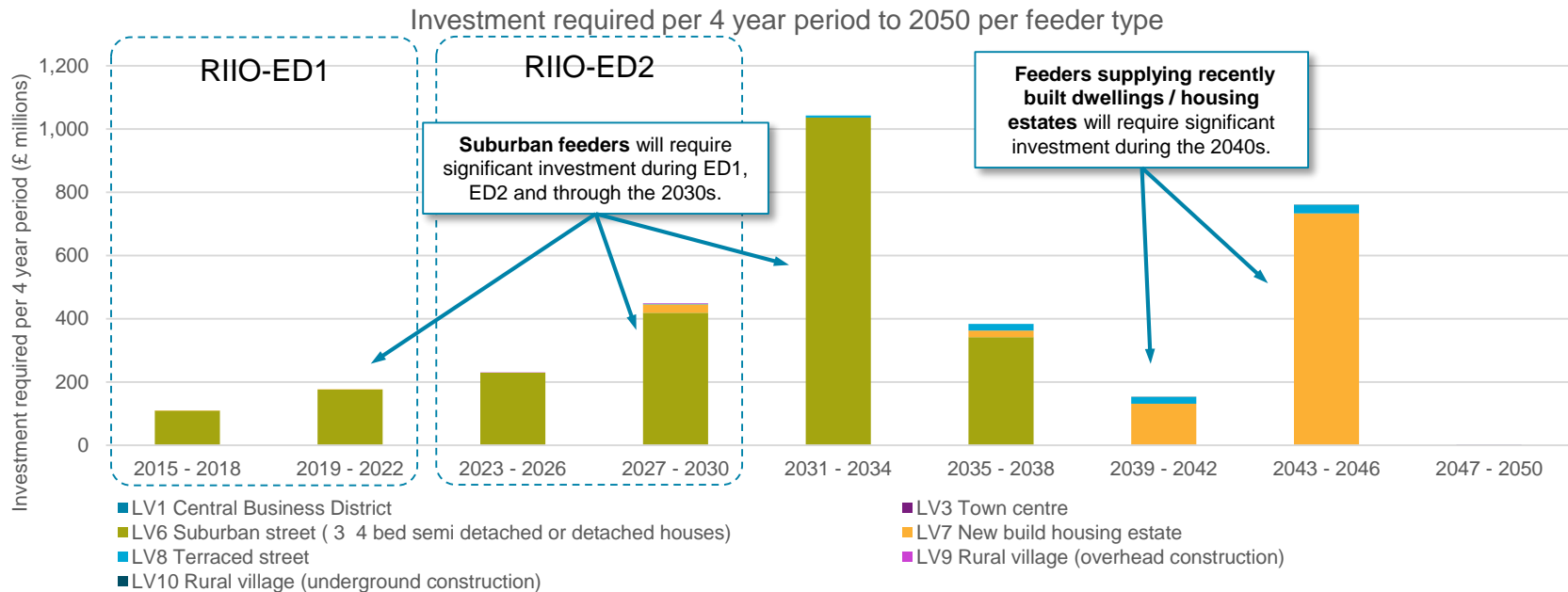

	2022	2030	2050
Cumulative costs associated with LV 6 suburban street (£)	285.9	933.8	2,311.6
Cumulative costs associated with LV 7 new build housing estate (£)	0.7	27.9	913.4
Cumulative costs associated with LV 8 terraced street (£)	0	1.6	77.1
Cumulative costs associated with other LV feeder types (£)	0	2.1	3.4
Total	286.6	965.4	3,306.5

Impact on ENWL's LV network of heat pump uptake under the 3 scenarios: Number of 'network interventions' & investment cost – high scenario

Huge investments in ENWL's low-voltage network will be required by 2050 to support the high scenario uptake of heat pumps if ENWL plans its network for an 'average' winter.

- Under the high scenario, we see ~200 interventions per year required in ED1, growing to 600 per year during ED2.
- By 2050, more than £2.5 billion will need to be invested in ENWL's network.
- Total network costs below are based on cost assumptions in Transform Version 5.0 from EATL. See annex for detailed assumptions.

Heat pump uptake under the high scenario:
1.15 million by 2050

Number of interventions required on the LV network per 4 year period

'Average' winter peak

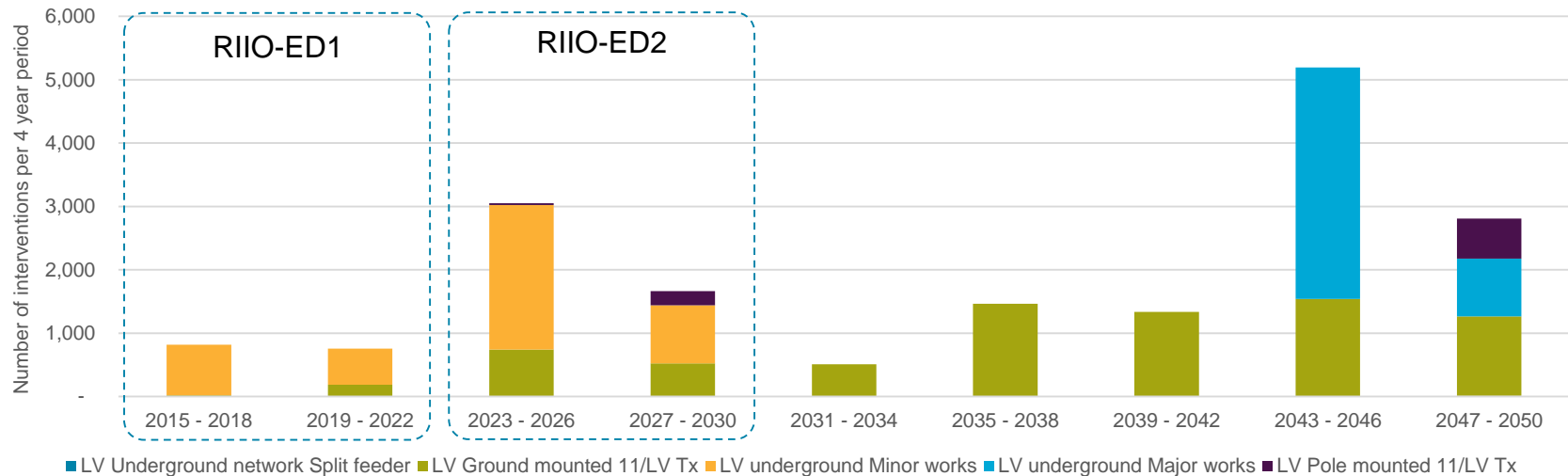

	2022	2030	2050
<i>Cumulative number of interventions required by end of time period</i>	1,577	6,291	17,594
Cumulative costs associated with LV Ground mounted upgrades (£ millions)	3.8	28.1	156.1
Cumulative costs associated with LV underground minor works (£ millions)	183.0	626.8	626.8
Cumulative costs associated with LV underground major works (£ millions)	0	0	1,785.0
Cumulative costs associated with LV pole mounted upgrades (£ millions)	0	2.1	8.1
Cumulative costs associated with LV underground network split feeder works (£ millions)	0	0	0.5
Total (millions)	186.8	657.0	2,576.5

Impact on ENWL's LV network of heat pump uptake under the 3 scenarios: Investment cost in ENWL's network by feeder type – high scenario

Significant investments will be required in suburban feeders by 2030, and again during the 2040s. Feeders serving terraced dwellings will require modest investments closer to 2050.

- Under the high scenario, significant investment will be required during ED1, ED2 & during the 2040s in feeders serving suburban areas (with large proportions of semi detached & detached dwellings).
- From 2030 onwards, small to modest investments are required in feeders serving terraced dwellings recently built new build housing estates.
- Total network costs below are based on cost assumptions in Transform Version 5.0 from EATL. See annex for detailed assumptions.

Heat pump uptake under the high scenario:
1.15 million by 2050

Investment required per 4 year period to 2050 per feeder type

‘Average’ winter peak

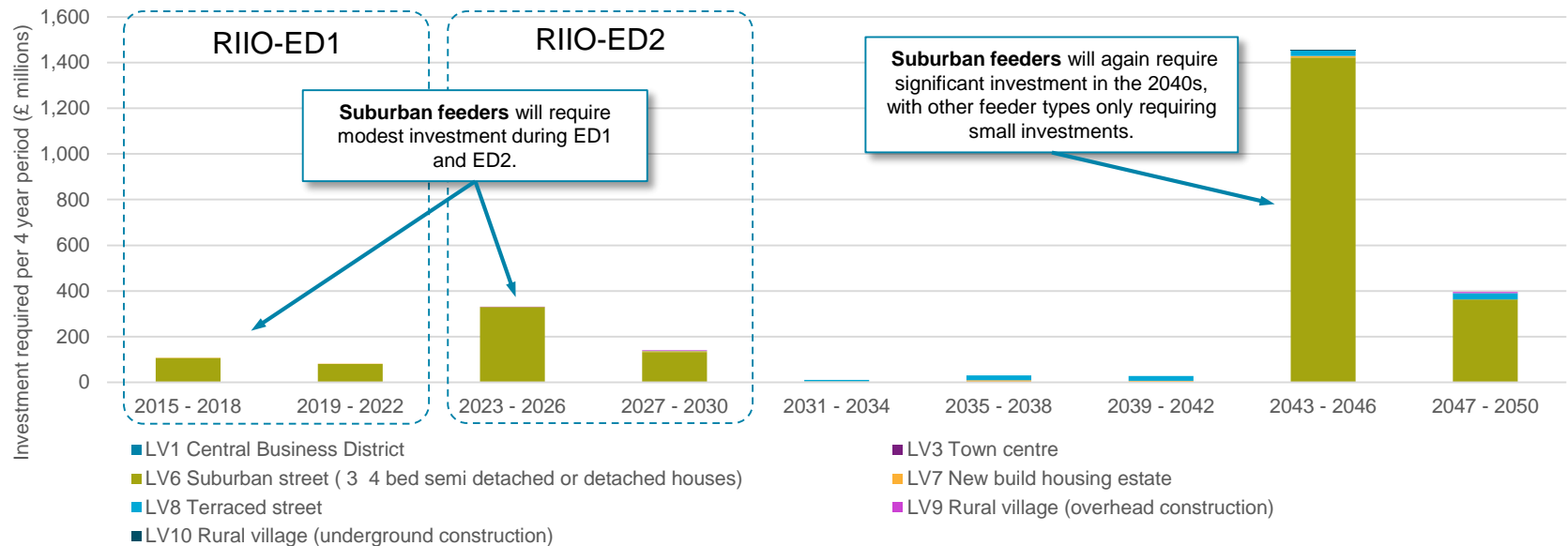

	2022	2030	2050
Cumulative costs associated with LV 6 suburban street (£ millions)	186.2	648.4	2,433.4
Cumulative costs associated with LV 7 new build housing estate (£ millions)	0.6	4.9	29.3
Cumulative costs associated with LV 8 terraced street (£ millions)	0	1.6	103.6
Cumulative costs associated with other LV feeder types (£ millions)	0	2.1	10.2
Total (£ millions)	186.8	657.0	2,576.5

Impact on ENWL's LV network of heat pump uptake under the 3 scenarios: Number of 'network interventions' & investment cost – low scenario

Modest investments in ENWL's low-voltage network will be required by 2050 to support the low scenario uptake of heat pumps if ENWL plans its network for a '1 in 20' winter.

- Under the low scenario, 10s of interventions per year are required during ED1 and ED2, growing to several 100s per year by 2050.
- This results in an overall modest investment requirement on ENWL's network of ~£150 million by 2050.
- Total network costs below are based on cost assumptions in Transform Version 5.0 from EATL. See annex for detailed assumptions.

Heat pump uptake under the low scenario:
130,000 by 2050

Number of interventions required on the LV network per 4 year period

'1 in 20' winter peak

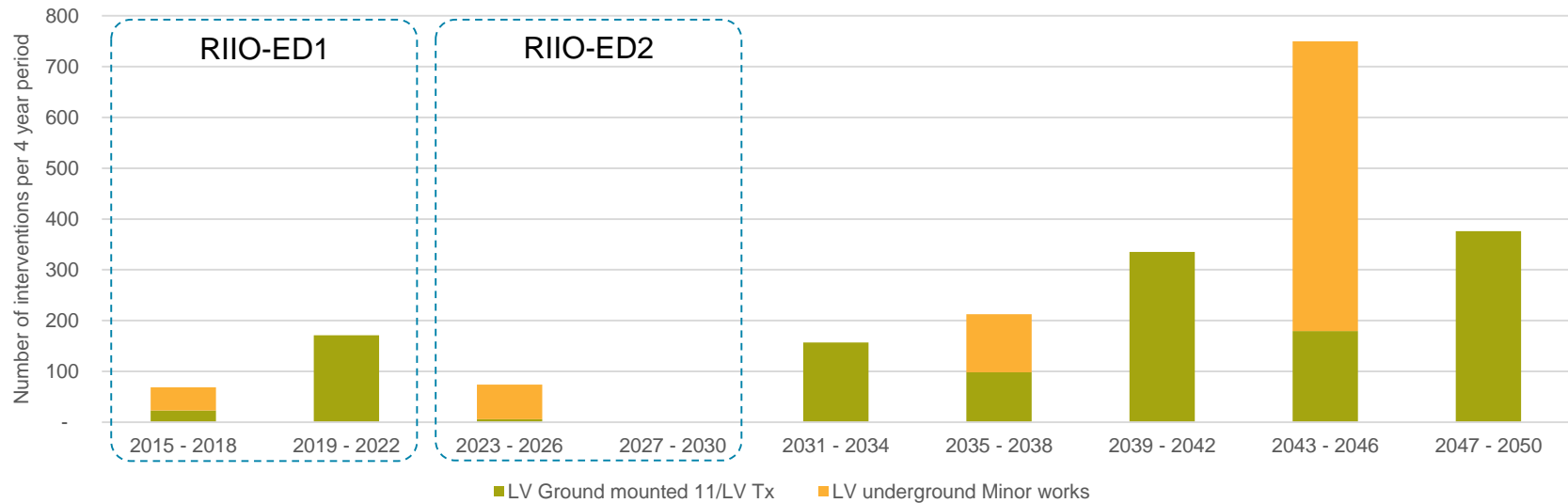

	2022	2030	2050
<i>Cumulative number of interventions required by end of time period</i>	240	314	2,145
Cumulative costs associated with LV Ground mounted upgrades (£ millions)	3.6	3.7	27.8
Cumulative costs associated with LV underground minor works (£ millions)	6.0	15.5	121.6
Total (£ millions)	9.6	19.2	149.4

Impact on ENWL's network of heat pump uptake under the 3 scenarios: Investment cost in ENWL's network by feeder type – low scenario

Only small investments will be required on ENWL's LV network by 2050, with suburban feeders accounting for the majority of this.

- Under the low scenario, very little investment will be required in ENWL's network before 2030.
- From 2035 onwards, suburban feeders are the only feeder type requiring significant investment, with most of this happening close to 2050.
- Total network costs below are based on cost assumptions in Transform Version 5.0 from EATL. See annex for detailed assumptions.

Heat pump uptake under the low scenario:
130,000 by 2050

Investment required per 4 year period to 2050 per feeder type

‘1 in 20’ winter peak

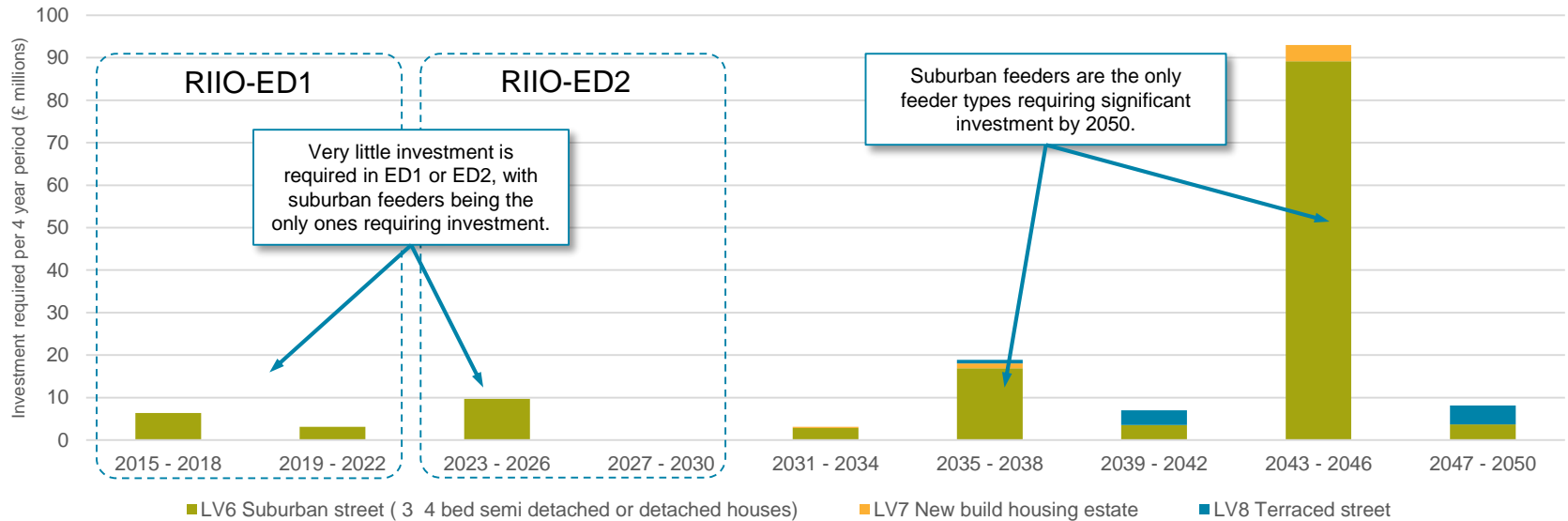

	2022	2030	2050
Cumulative costs associated with LV 6 suburban street (£ millions)	9.6	19.2	135.4
Cumulative costs associated with LV 7 new build housing estate (£ millions)	0	0	5.3
Cumulative costs associated with LV 8 terraced street (£ millions)	0	0	8.7
Total (£ millions)	9.6	19.2	149.4

Impact on ENWL's LV network of heat pump uptake under the 3 scenarios: Number of 'network interventions' & investment cost – low scenario

Small investments in ENWL's low-voltage network will be required by 2050 to support the low scenario uptake of heat pumps if ENWL plans its network for an 'average' winter.

- Under the low scenario, low 10s of interventions per year are required during ED1 and ED2, growing to ~100 per year by 2050.
- This results in an overall modest investment requirement on ENWL's network of ~£25 million by 2050.
- Total network costs below are based on cost assumptions in Transform Version 5.0 from EATL. See annex for detailed assumptions.

Heat pump uptake under the low scenario:
130,000 by 2050

Number of interventions required on the LV network per 4 year period

'Average' winter peak

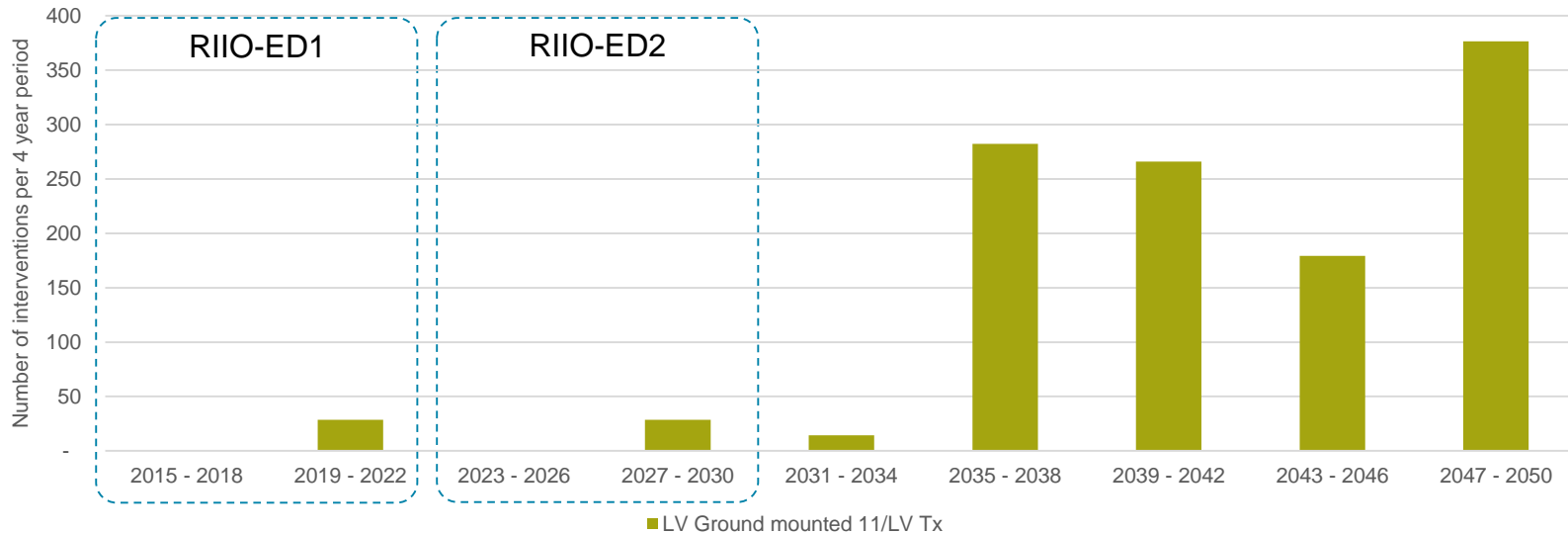

	2022	2030	2050
Cumulative number of interventions required by end of time period	29	57	1,175
Cumulative costs associated with LV Ground mounted upgrades (£ millions)	0.5	1.1	24.7
Total	0.5	1.1	24.7

Impact on ENWL's network of heat pump uptake under the 3 scenarios: Investment cost in ENWL's network by feeder type – low scenario

Only small investments will be required on ENWL's LV network by 2050, with suburban feeders accounting for the majority of this.

- Under the low scenario, very little investment will be required in ENWL's network before 2030.
- From 2035 onwards, suburban feeders are the only feeder type requiring significant investment, with most of this happening close to 2050.
- Total network costs below are based on cost assumptions in Transform Version 5.0 from EATL. See annex for detailed assumptions.

Heat pump uptake under the low scenario:
130,000 by 2050

‘Average’ winter peak

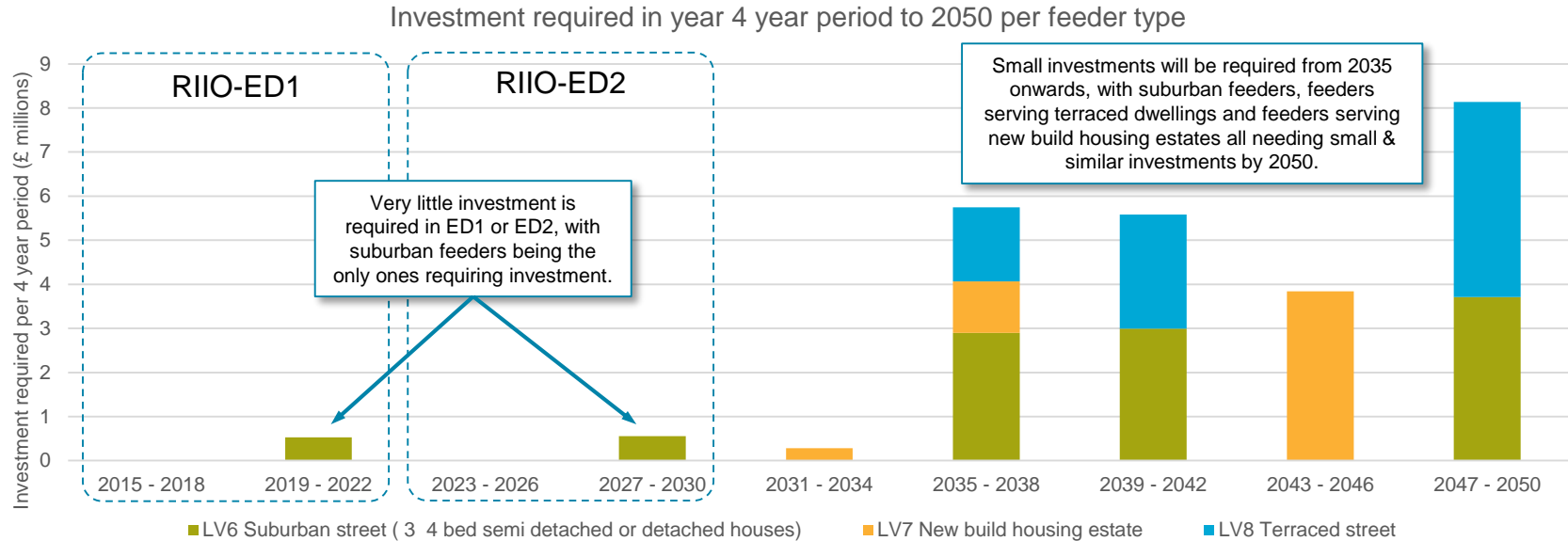

	2022	2030	2050
Cumulative costs associated with LV 6 suburban street (£ millions)	0.5	1.1	10.7
Cumulative costs associated with LV 7 new build housing estate (£ millions)	0	0	5.3
Cumulative costs associated with LV 8 terraced street (£ millions)	0	0	8.7
Total (£ millions)	0.5	1.1	24.7

Executive Summary	4
Introduction & project scope	12
Overview of different heat pump technologies	14
▶ High level description of the different types of heat pump technologies	
▶ Technology costs, performance & 'fit' into different house types – current & future	
▶ Summary of housing stock in ENWL's region & defining the 6 heat pump – house type combinations	
High level overall methodology	22
Heat pump load profile outputs	24
▶ Methodology for developing granular & robust heat pump load profiles	
▶ Review of existing studies & projects measuring heat pump load profiles	
▶ Temperature profiles considered in this analysis & selection of outputs from our building physics modelling	
▶ Results from developing load profiles for different heat pumps in different house types	
Diversifying heat pump load profiles & clustering of heat pumps	32
▶ Overview of approach	
▶ Outputs of diversification of heat pump load profiles	
▶ Clustering assumptions for allocating different heat pump types to different LV feeder types	
Forecasting heat pump uptake rates and low-voltage distribution network impacts	44
▶ Developing the three scenarios for heat pump uptake on ENWL's network	
▶ Impact of heat pump uptake on ENWL's low-voltage distribution network – network interventions & cost of upgrading the network	
Optimisation of heat pump load profiles	69
▶ Overview of optimisation approach	
▶ Flexibility of HP operation	
▶ Outputs from Imperial's optimisation modelling – optimised load profiles	
▶ Impact of the optimised profiles on ENWL's network	
Customer side measure analysis	80
▶ Description of customer side measures & approach for assessing these measures	
▶ Analysis & quantification of reduction in the impact implementation of these measures have on ENWL's network	
Recommendations	111
Annexes	113

'Optimisation' of heat pump load profiles by other energy system stakeholders: Overview of the approach used

Will 'optimised' operation of heat pumps increase peak load on the distribution network for ENWL?

- ▶ For DNOs, a growth in heat pump uptake presents the opportunity to distribute more electricity, invest more in the network and generate more revenue. The timing of this new demand could overlap with existing 'peak load' times, presenting new challenges to DNOs in terms of the capacity requirements of the network.
- ▶ Adding to this, other players in the electricity value chain (electricity suppliers and the system operator) may also begin to influence the operation of electric heating & heat pumps to optimise the operation of the wider electricity system (e.g. influencing electricity demand to maximise the use of low cost electricity). This 'optimisation' will be based on national, rather than local, price signals.
- ▶ 'Optimisation' of heat pump operation at the system level could actually increase the stresses that heat pump load causes at the DNO level (e.g. if price signals shift / encourage heat pump load to increase at peak load times), making the challenge for ENWL even higher.
- ▶ Delta-ee has therefore assessed the impact that 'optimised' heat pump load profiles will have on ENWL's network.

Definition of 'optimisation':

We modify the operation of heat pumps (by altering their load profiles) to maximise consumption of low cost renewable electricity – so that we lower the overall cost of electricity generation.

Note - we do not consider the impacts of this on the distribution network during the 'optimisation' process.

Approach to optimising heat pump load profiles

Step 1: Diversify heat pump load profiles at the national level

- ▶ Optimisation of the electricity system will happen at the *national* level, influenced by the total electricity load of all heat pumps in the UK. Therefore heat pump load profiles need to be diversified at the *national* level.

Step 2: Identify the 'flexibility' options around the operation of heat pumps (without compromising on the level of comfort and timing of delivery of heating in a dwelling)

- ▶ Depending on the level of insulation of homes, the thermal mass of the building and the size of hot water / buffer tanks, heat pump operation can be influenced in different ways.
- ▶ This means the operation of heat pumps in different house types can be interrupted for short periods or brought earlier in the day – if (for example) price signals / third party control of heat pumps is introduced.

Step 3: Define a scenario to 2050 for the evolution of electricity demand, the generation mix, and the uptake of heat pumps at the national level

- ▶ Optimisation of heat pump operation at the national level will critically depend on how **total** electricity demand (heat pump & non heat pump) evolves and the generation mix available to satisfy this demand.
- ▶ National Grid's 'Gone Green' scenario for the generation mix and total electricity demand has been used in this analysis.

Step 4: Optimise the operation of the electricity system at the national level via shifting the operation of heat pumps to maximise use of lower cost electricity generation.

- ▶ **Imperial College** has used its ASUC model to simulate and optimise the operation of the UK electricity system. The ASUC model minimises the cost of operation of the system by influencing the timing of electricity demand to maximise the use of low cost renewable (wind) generation.
- ▶ Delta-ee's low, reference and high heat pump uptake rates have been modelled separately.

OUTPUT: Modified heat pump load profiles

- ▶ Delta-ee will model the change in impact on ENWL's network using these modified load profiles.

Step 5: Sense check and validation of modified load profiles

- ▶ New profiles need to be sense checked to ensure that the heat load of a dwelling is still satisfied and that comfort levels are not compromised.

Optimising the operation of the UK electricity system

- ▶ Delta-ee has worked with Imperial college to generate 'optimised' heat pump load profiles that allow the UK electricity system to operate at lowest cost from the supply side.
- ▶ Imperial has used its ASUC model to run this optimisation, a key output of which is **modified heat pump load profiles**.
- ▶ Below, we illustrate the methodology behind the ASUC model.

Stochastic electricity system scheduling using ASUC model

Step 1: Define scenarios for the electricity generation mix, electricity demand & flexibility of the energy system to 2050

- ▶ Key inputs into Imperial's ASUC model include scenarios for the *generation mix* and *electricity demand* (including demand from heat pump).
- ▶ A range of assumptions on the technical operation and cost parameters of generators are included, as well as assumption on the flexible operation of the system (e.g. amount of energy storage / demand side response available, flexibility of heat pump load).

Step 2: Simulate uncertainty in the availability of renewable generation & conventional generation in the future, and also in electricity demand forecasting

- ▶ Based on representative UK data, stochastic models of random variations are built for **3 key random variables**: 1) wind and PV output; 2) demand forecasting errors (uncertainty in predicting demand a few hours ahead); generator outages.

Step 3: Generate 'scenario trees' for the possible future realisations of the three stochastic variables in step 2

- ▶ Based on the uncertainties mentioned in step 2, the ASUC model builds 'scenario trees' for random variables that are statistically representative of actual data.
- ▶ These 'scenario trees' are typically generated for 24 hours ahead.

Step 4: Minimise expected operating cost of the system by dispatching generation plant and shifting heat pump load (within the defined flexibility constraints)

- ▶ ASUC makes operating decisions to the energy system to minimise the *expected cost of electricity generation*. The process iterates in a "rolling planning window", moving one hour ahead in each step and re-generating the scenario trees.
- ▶ ASUC also dynamically allocates reserve capacity in the system to maintain security of supply in a cost-optimal fashion.

MODEL OUTPUTS:

1. Utilisation percentage of generation assets
2. Operation of heat pumps in a way that is 'optimal' for the generation mix (i.e. minimises overall generation cost)
3. Total system operating cost and carbon emissions
4. Renewable output curtailment
5. Marginal cost of electricity

- ▶ The ASUC model provides as an output a set of optimal operating decisions for generation, demand side response and storage assets over the analysed period (typically up to one year).
- ▶ Outputs also include total system operation cost, as well as its carbon performance and the ability of the system to integrate intermittent renewable output.
- ▶ Marginal cost of electricity is also calculated in the model.

The load profiles of the 6 heat pump house types are modified (within constraints based on how flexible the operation of heat pumps can be) to enable this 'optimal' operation of heat pumps. 'Optimised' heat pump load profiles are an output from the ASUC model.

What affects heat pump flexibility?

Defining heat pump ‘flexibility’: Heat pump operation can be **‘flexible’** if its operation can be interrupted (i.e. switched off) for periods of time during the day, or if the timing of its operation can be moved to other times of the day (e.g. if there is a buffer tank, this can be heated up earlier in the day to avoid operation of the heat pump during peak demand times).

The three main factors enabling heat pump flexibility are the building’s insulation, its thermal mass and the capacity of any existing buffer tanks:

- ▶ **Insulation:** The insulation level of a building determines its rate of energy loss. The higher the insulation level of a building, the longer it will take for its indoor temperature to reduce by 1° C. A HP in a highly insulated building can therefore be switched off for a longer time than a HP in a lowly insulated building without the inhabitants getting cold.
- ▶ **Thermal Mass:** The thermal mass of a building determines how much heat can be stored in its wall, floors and ceilings by heating them up. A building with a high thermal mass will be able to keep its temperature for longer, as the heated mass of the building will not only “lose” heat to the outside, but also to the inside of the building. A high thermal mass combined with a high level of insulation is therefore ideal for enabling flexibility, as it reduces losses to the outside of the building.
- ▶ **Buffer Tank capacity:** The use of buffer tanks is another way to increase the flexibility a HP can provide. By heating up water in a buffer tank when it is not needed in the house, this energy can be used in the building at a later time. For this approach to work it is important for the buffer tank to not be constantly “in line” with the heat distribution system of the building.

Another important factor influencing the flexibility of a heat pump is the intelligence of its control system. The more the control system knows and learns about the expected flexibility requirements in the near term (a few hours to one day ahead), the requirements of the occupants and the reaction of the building to specific demand response interventions, the better it will be able to optimise the use of its flexibility potential.

Summary of the level of flexibility offered by different heat pump house types

	House Type	Heating System	Flexibility w/o buffer	Flexibility with buffer
#1	Semi-detached (1959) Thermal Mass: Medium; Insulation: Medium	Lower temperature heat pump	Medium	High
#2	New build semi (2010) Thermal Mass: Low; Insulation: High	Lower temperature heat pump	High	High
#3	Semi detached (1959) Thermal Mass: Medium; Insulation: Low	Higher temperature heat pump	Low	Medium
#4	Detached (1930) Thermal Mass: High; Insulation: Low	Hybrid heat pump	Very High (unlimited)	n/a
#5	Semi detached (1959) Thermal Mass: Medium; Insulation: Low	Hybrid heat pump	Very High (unlimited)	n/a
#6	Terrace (1909) Thermal Mass: High; Insulation: Low	Hybrid heat pump	Very High (unlimited)	n/a

Impact of the 'optimisation' of all heat pumps at the National level – Reference scenario

Impact of 'optimisation' on the overall electricity demand from ALL heat pumps in the installed base in 2050.

- ▶ In the chart below, we illustrate the total electricity demand from ALL heat pumps over one day on ENWL's network in 2050, (under the reference scenario) both before and after 'optimisation' by Imperial's ASUC model. We also plot the price of electricity from marginal generation plant (the key driver of optimisation in Imperial's ASUC model) over the course on one day to illustrate the impact that electricity price has on the operation of heat pumps.
- ▶ Before 'optimisation', the maximum load from all heat pumps peaked at ~820 MW. **After 'optimisation', when the operation of all heat pumps is influenced to maximise the use of lower cost electricity, we see the maximum load increasing to ~930 MW (a 10 – 15% increase).** Considering only the evening heating period (16:00 – 23:00), when peak electricity demand on ENWL's network currently occurs, we see the maximum load increasing from ~780 MW (at 21:30 in the chart below) to ~900 MW (at 17:00 in the chart below). This is 15% increase in electricity demand during 'peak demand' times resulting from the optimisation of heat pump operation.
- ▶ Note – the chart below illustrate just one day, during an 'average' winter week.
- ▶ Typically, during 'average' winter days, 'optimisation' results in a small increase in both load from ASHPs and hybrids, typically adding 5 – 15% onto the maximum load from all heat pumps.
- ▶ On '1 in 20' winter days however, we can see a much more significant impact due to hybrid heat pumps (which usually do not operate during very cold spells) switching on, and from the back up electric heaters of ASHPs occasionally switching on. This can result in the maximum load increasing typically by 15 – 25%.

Electricity load from ALL heat pumps - before and after 'optimisation'

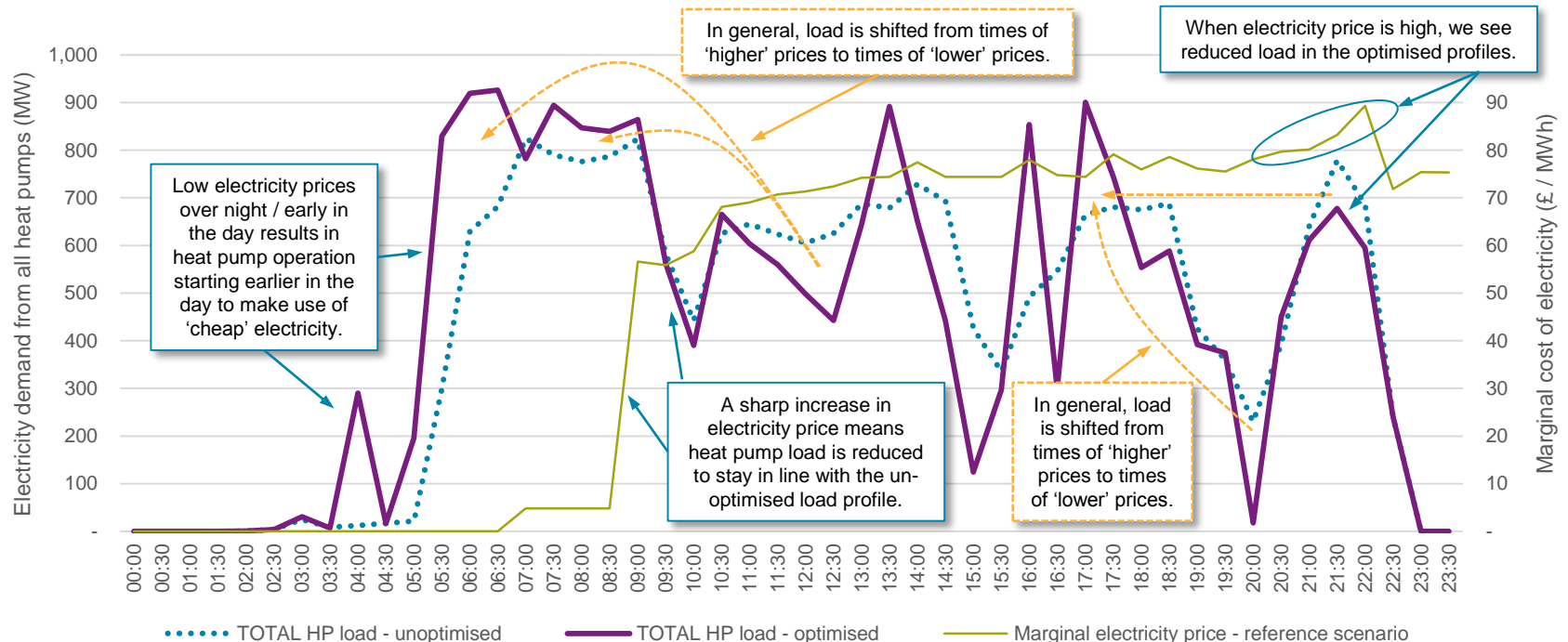

Impact of optimisation on hybrid heat pump operation on a day in a '1 in 20' winter and an 'average' winter week – Reference scenario

Optimisation of hybrid heat pump operation can increase demand at peak times by up to 3kW.

- ▶ Under our reference scenario, optimisation of hybrid heat pump operation increases the peak load on both 'average' & '1 in 20' winter days.
- ▶ On 'average' winter days, electricity demand during the evening peak period is increased by 1 – 2 kW. On '1 in 20' winter days, when the electric part of hybrid heat pumps typically do not operate (due to efficiency issues), if it is windy and electricity is cheap, the optimised hybrid profile can result in load at peak times increasing by 3 kW.
- ▶ Below, we illustrate the un-optimised and the optimised load profiles for a hybrid heat in a detached dwelling on a day during an 'average' winter week (top chart) and on a day during a '1 in 20' winter week (bottom chart).

Un-optimised & optimised load profile for hybrid in detached on an 'average' peak winter day

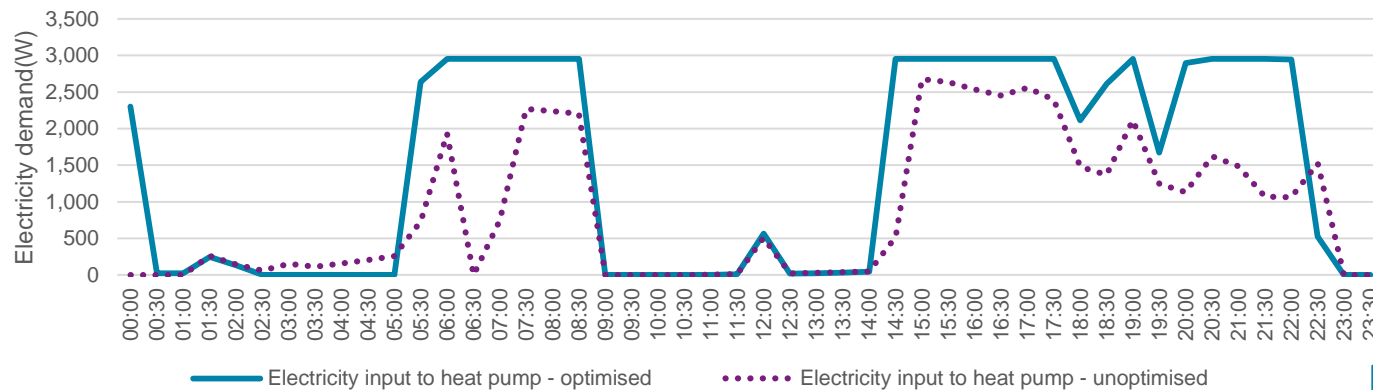

Reference scenario
Hybrid in detached
'Average' winter day

Similar results are observed when we consider the high scenario uptake rates for heat pumps.

Un-optimised & optimised load profile for hybrid in detached on a '1 in 20' peak winter day

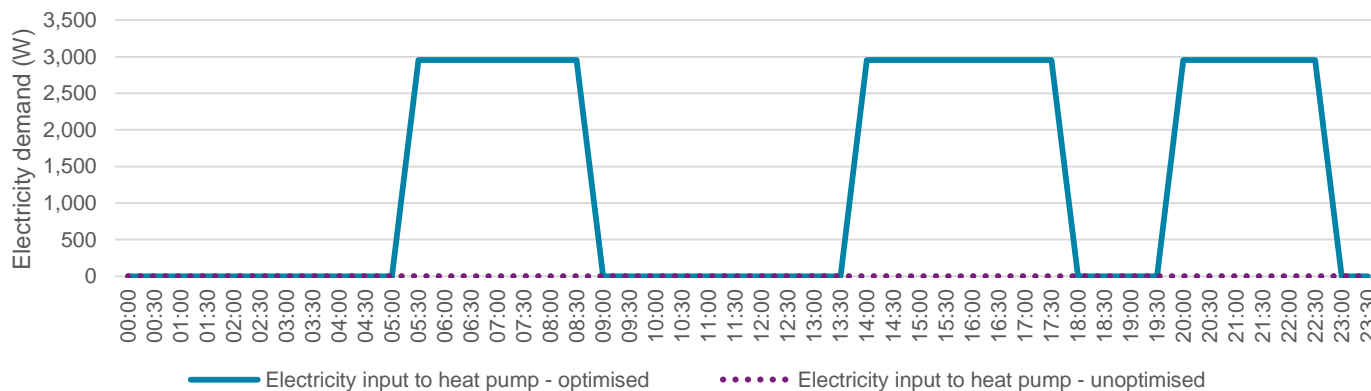

Reference scenario
Hybrid in detached
'1 in 20' winter day

Impact of optimisation on electric heat pump operation on a day in a '1 in 20' and an 'average' winter week – Reference scenario

Optimisation of ASHP operation can increase demand at peak times by up to 0.5 – 1 kW (and in some cases by a few kW if the back up turns on).

- ▶ Under our reference scenario, optimisation of pure electric heat pump operation increases the peak load on both 'average' & '1 in 20' winter days.
- ▶ On 'average' winter days, electricity demand during the evening peak period is increased typically by 0.5 – 1 kW. On some days, if electricity price is low enough, the back up electric heater may actually turn on.
- ▶ On '1 in 20' winter days, when the heat pump and back up electric heater are both working at maximum output, we see no increase in the peak load. However, we tend to see the length of time at with the heat pump operates at maximum load reducing.
- ▶ Below, we illustrate the un-optimised and the optimised load profiles for a hybrid heat in a detached dwelling on a day during an 'average' winter week (top chart) and on a day during a '1 in 20' winter week (bottom chart).

Un-optimised & optimised load profile for HT ASHP in semi on an 'average' winter day

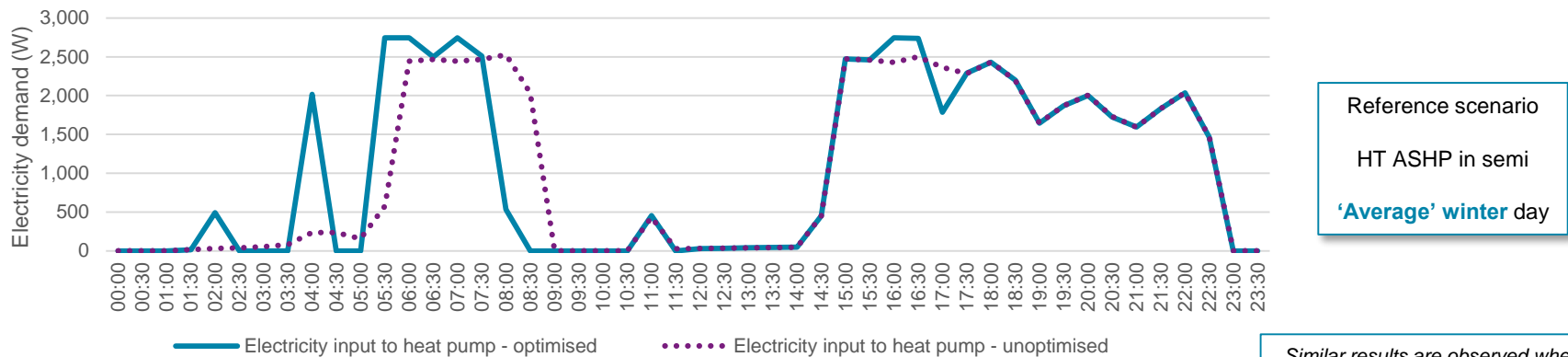

Similar results are observed when we consider the high scenario uptake rates for heat pumps.

Un-optimised & optimised load profile for HT ASHP in semi on a '1 in 20' winter day

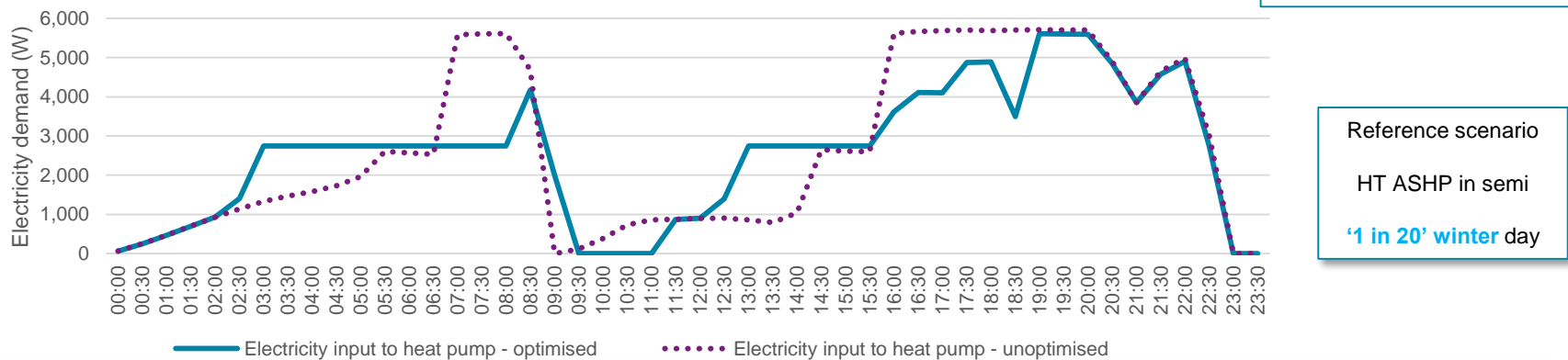

Reference scenario
HT ASHP in semi
'1 in 20' winter day

Impact of 'optimised' heat pump load profiles on ENWL's network

Reference scenario during a '1 in 20' winter

Optimisation of heat pump load profiles increases the pressure on ENWL's network, with 20 – 50% more interventions being required during the 2030s & 2040s.

- Under our reference scenario, 'optimisation' of heat pump load profiles to absorb more low cost electricity from renewable generation increases the peak load of both hybrid heat pumps and ASHPs on '1 in 20' peak winter days. This has limited impact on the network before 2030, but starts making a significant impact during the 2030s.
- Heat pump profiles influenced by price signals when electricity at the system level is cheap results in 20 – 50% more network interventions under our reference scenario in the 2030 – 2050 period. By 2050, the total number of network interventions required if heat pump operation is 'optimised' increases by 24%.

Cumulative number of interventions under the reference scenario with un-optimised & optimised heat pump load profiles - 1 in 20 winter

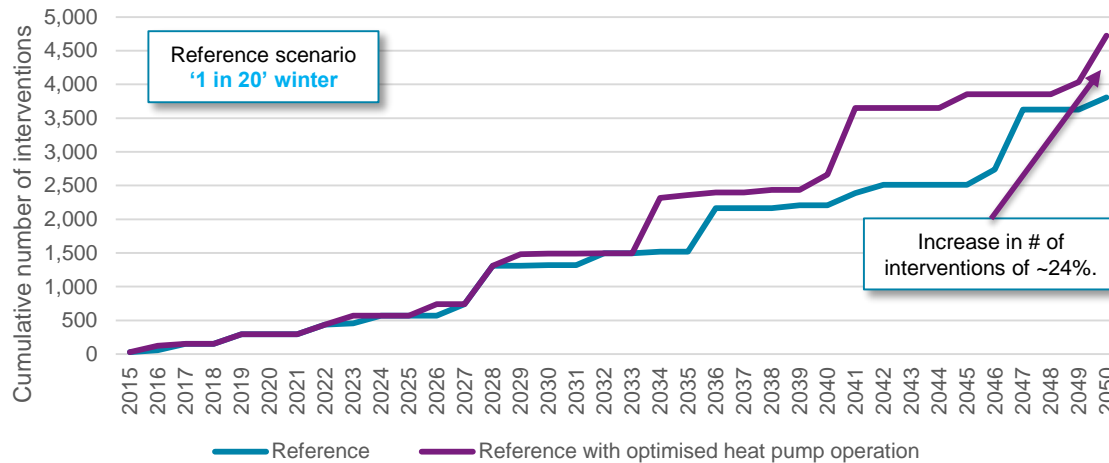

Commentary

- With 'optimised' heat pump operation, the number of interventions required by 2050 increases by almost 1,000 (around 24% more by 2050).
- The additional interventions required are primarily 'minor ground works'.
- While there is still a modest number of network interventions required, the optimisation of heat operations results in an additional £109 million investment being required on ENWL's network by 2050.

Effect of 'optimising' heat pump operation on ENWL's network at the LV feeder level:

Cumulative <u>number of network interventions</u>	2022	2030	2050
Reference	439	1,320	3,808
Reference with 'optimised' heat pump load profiles	439	1,491	4,721

Cumulative <u>investment</u> required on the LV network	2022	2030	2050
Reference (£ million)	21.0	121.3	339.2
Reference with 'optimised' heat pump load profiles (£ million)	21.0	124.5	447.7
Additional cost to ENWL by optimisation of HP operation (£ million)	0	3.2	108.5

Overall increase in number of interventions by 2050:

24 %

Overall impact on investment required by 2050:

£ 109 million

'1 in 20' winter peak

Impact of 'optimised' heat pump load profiles on ENWL's network Reference scenario during an 'average' winter

Optimisation of heat pump load profiles increases the pressure on ENWL's network, with 70% more interventions being required by 2050.

- Under our reference scenario, 'optimisation' of heat pump load profiles to absorb more low cost electricity from renewable generation increases the peak load of both hybrid heat pumps and ASHPs on 'average' peak winter days. This more than doubles the number of network interventions required during the 2020s and 2030s compared to the un-optimised operation of heat pumps.
- Heat pump profiles influenced by price signals when electricity at the system level is cheap results in 70% more network interventions under our reference scenario.

Cumulative number of interventions under the reference scenario with un-optimised & optimised heat pump load profiles – 'average' winter

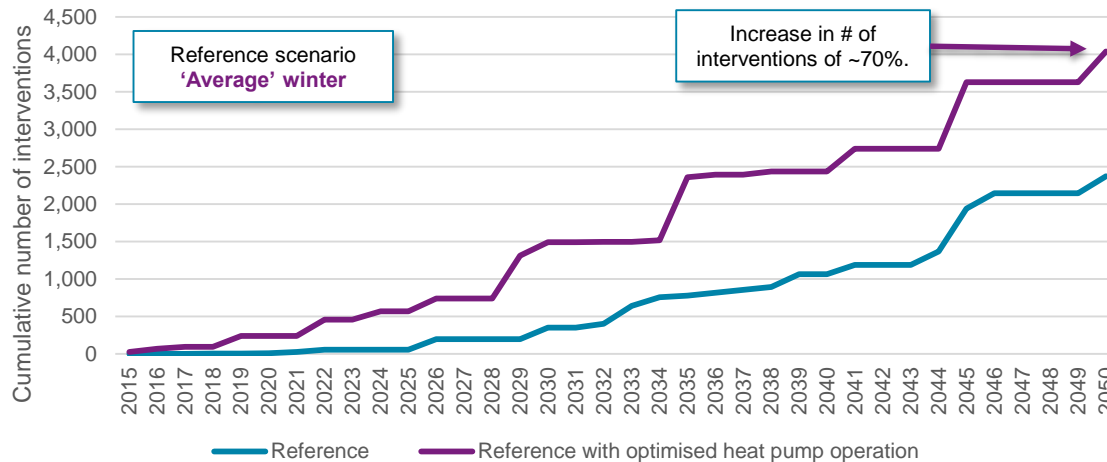

Commentary

- With 'optimised' heat pump operation, the number of interventions required by 2050 increases by 1,600 (around 70% more by 2050).
- The additional interventions required are primarily 'minor ground works'.
- The optimisation of heat operations results in an additional £190 million investment being required on ENWL's network by 2050.

'Average' winter peak

Effect of 'optimising' heat pump operation on ENWL's network at the LV feeder level:

Cumulative <u>number of network interventions</u>	2022	2030	2050
Reference	57	350	2,373
Reference with 'optimised' heat pump load profiles	457	1,491	4,036

Cumulative <u>investment</u> required on the LV network	2022	2030	2050
Reference (£ million)	1.1	6.7	154.4
Reference with 'optimised' heat pump load profiles (£ million)	21.7	125.4	343.0
Additional cost to ENWL by optimisation of HP load profiles (£ million)	20.6	118.7	188.6

Overall increase in number of interventions by 2050:

70 %

Overall impact on investment required by 2050:

£ 189 million

Impact of 'optimised' heat pump load profiles on ENWL's network High scenario during a '1 in 20' winter

Optimisation of heat pump load profiles increases the pressure on ENWL's network, with ~10% more interventions being required by 2050.

- Under our high scenario, optimisation of profiles increases the peak load of both hybrid heat pumps and ASHPs on '1 in 20' peak winter days.
- Heat pump profiles influenced by price signals when electricity at the system level is cheap, results in ~20% more network interventions being required during the start of the 2030s and in ~15% during the early 2040s. This converges slightly towards 2050, with the increase in the number of interventions required when optimised profiles are considered shrinking to ~10%. Lower cost ground mounted and pole mounted transformer upgrades account for all of this 10% increase by 2050, resulting in only a small additional investment in the network being required.

Cumulative number of interventions under the high scenario with un-optimised & optimised heat pump load profiles - 1 in 20 winter

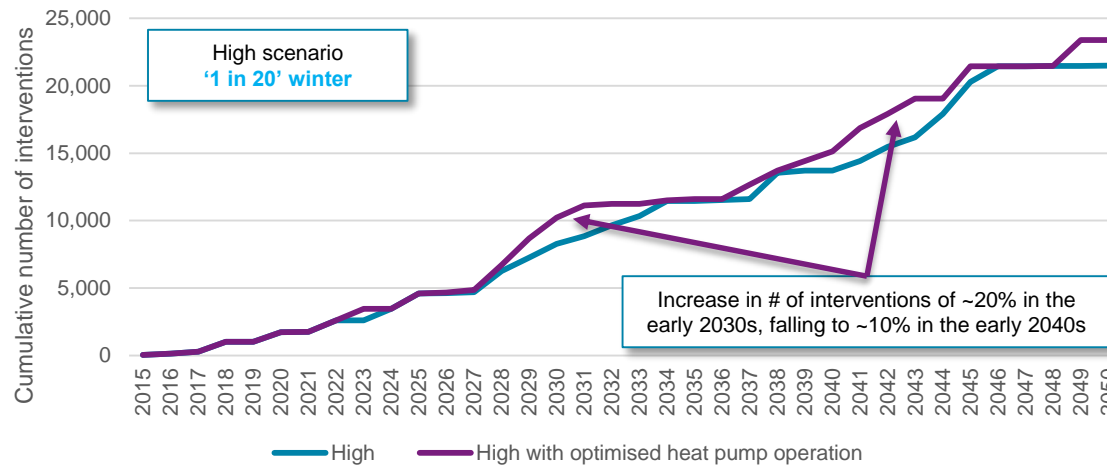

Commentary

- With 'optimised' heat pump operation, the number of interventions required by 2050 increases by ~2,000 (around 9% more by 2050).
- The additional interventions required by 2050 are lower cost 'pole mounted' and 'ground mounted' transformer upgrades.
- While there is a relatively small amount of additional interventions (and associated investment costs) by 2050, we do see significant more 'major underground' interventions taking place during the 2020s meaning large investments that previously occurred in the 2030s now occurring during the 2020s.

'1 in 20' winter peak

Effect of 'optimising' heat pump operation on ENWL's network at the LV feeder level:

Cumulative <u>number of network interventions</u>	2022	2030	2050
High	2,604	8,273	21,482
High with 'optimised' heat pump load profiles	2,604	10,213	23,392
Cumulative <u>investment</u> required on the LV network	2022	2030	2050
High (£ million)	286.6	965.4	3,306.5
High with 'optimised' heat pump load profiles (£ million)	286.6	1,655.8	3,311.1
Additional cost to ENWL by optimisation of HP load profiles (£ million)	0	690.4	4.6

Overall increase in number of interventions by 2050:

9 %

Overall impact on investment required by 2050:

£5 million

Impact of 'optimised' heat pump load profiles on ENWL's network High scenario during an 'average' winter

Optimisation of heat pump load profiles increases the pressure on ENWL's network, with ~5% more interventions being required by 2050.

- Under our high scenario, optimisation of profiles increases the peak load of both hybrid heat pumps and ASHPs on 'average' peak winter days.
- Heat pump profiles influenced by price signals when electricity at the system level is cheap, results in ~20 – 40% more network interventions being required during the 2030s and in 50 – 60% during the early 2040s. This converges towards 2050, with the increase in the number of interventions required when optimised profiles are considered shrinking to ~5%. Despite slightly more interventions being required by 2050, we actually see a small reduction in the overall investment costs required. This is due to the majority of the 'major groundworks' interventions required occurring in the 2020s (as opposed late in the 2040s when considering the un-optimised load profiles) making overall investment costs higher out to 2030, but lower overall by 2050. These interventions get more costly to implement in the future.

Cumulative number of interventions under the high scenario with un-optimised & optimised heat pump load profiles - 1 in 20 winter

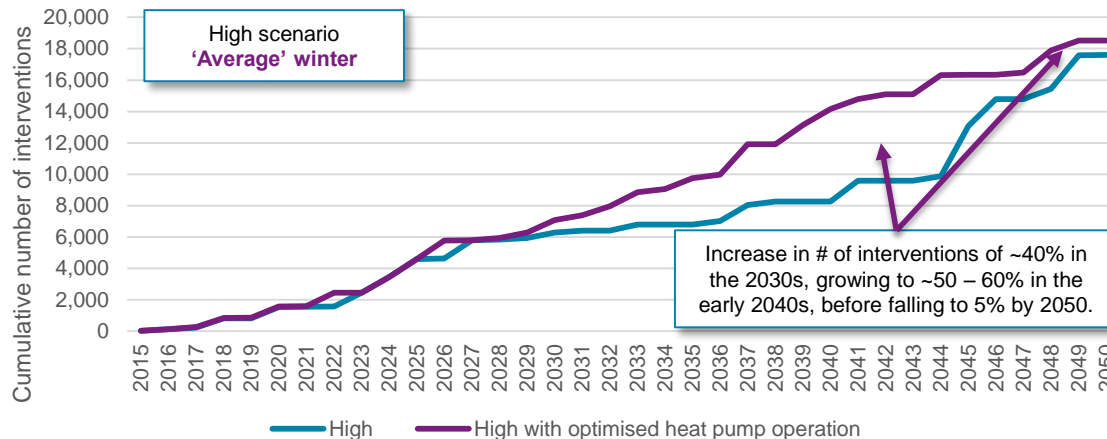

Commentary

- With 'optimised' heat pump operation, the number of interventions required by 2050 increases by ~1,000 (around 5% more by 2050).
- The additional interventions required by 2050 are lower cost 'pole mounted transform' upgrades and 'minor groundworks'.
- While there is a small amount of additional interventions by 2050, we actually see the majority of 'major underground' interventions taking place during the 2020s meaning large investments that previously occurred in the 2040s now occurring during the 2020s. As this intervention gets more expensive the later it occurs, by implementing these interventions in the 2020s, we see a small reduction in the overall network investment required by 2050.

'Average' winter peak

Effect of 'optimising' heat pump operation on ENWL's network at the LV feeder level:

Cumulative <u>number of network interventions</u>	2022	2030	2050
High	1,577	6,291	17,594
High with 'optimised' heat pump load profiles	2,461	7,090	18,522
Cumulative <u>investment</u> required on the LV network	2022	2030	2050
High (£ million)	186.8	657.0	2,576.5
High with 'optimised' heat pump load profiles (£ million)	284.0	941.4	2,517.1
Additional cost to ENWL by optimisation of HP load profiles (£ million)	97.2	284.4	-59.4

Overall increase in number of interventions by 2050:

5 %

Overall impact on investment required by 2050:

- £59 million

Executive Summary	4
Introduction & project scope	12
Overview of different heat pump technologies	14
▶ High level description of the different types of heat pump technologies	
▶ Technology costs, performance & 'fit' into different house types – current & future	
▶ Summary of housing stock in ENWL's region & defining the 6 heat pump – house type combinations	
High level overall methodology	22
Heat pump load profile outputs	24
▶ Methodology for developing granular & robust heat pump load profiles	
▶ Review of existing studies & projects measuring heat pump load profiles	
▶ Temperature profiles considered in this analysis & selection of outputs from our building physics modelling	
▶ Results from developing load profiles for different heat pumps in different house types	
Diversifying heat pump load profiles & clustering of heat pumps	32
▶ Overview of approach	
▶ Outputs of diversification of heat pump load profiles	
▶ Clustering assumptions for allocating different heat pump types to different LV feeder types	
Forecasting heat pump uptake rates and low-voltage distribution network impacts	44
▶ Developing the three scenarios for heat pump uptake on ENWL's network	
▶ Impact of heat pump uptake on ENWL's low-voltage distribution network – network interventions & cost of upgrading the network	
Optimisation of heat pump load profiles	69
▶ Overview of optimisation approach	
▶ Flexibility of HP operation	
▶ Outputs from Imperial's optimisation modelling – optimised load profiles	
▶ Impact of the optimised profiles on ENWL's network	
Customer side measure analysis	80
▶ Description of customer side measures & approach for assessing these measures	
▶ Analysis & quantification of reduction in the impact implementation of these measures have on ENWL's network	
Recommendations	111
Annexes	113

The full range of residential DSM “customer side measures” that could be implemented to manage network constraints

There is a wide range of customer side measures that ENWL could introduce to manage and influence the impact of electric heating on its network that are heating related (e.g. influencing the control / operation of heat pumps). There are also a number of measures that ENWL could introduce that are non-heating related. For example, influencing the operation of electric vehicles or non-heating household appliances to coincide with non-heating times of the day.

Below, we list a wide range of customer side measures that ENWL could implement, grouping these into key themes. *Note – in the slides that follow, we only consider the impact of introducing those measures that focus on heating.*

Reduce demand

1. Better controls / insulation. Reducing (electric) heat demand, reducing standby, reduced lighting
2. More efficient appliances. Heating, appliances, lighting
3. Incentivise non-electric showers
4. Customer behaviour. Switching appliances off or down, e.g. via competitions.

Reduce overall energy demand, which will also reduce peaks.

Multiple energy sources

1. Different energy vectors working to support each other.
2. Energy *system* approach

Examples include hybrid heat pumps; using micro-CHP to support voltage levels; solar thermal water heating. Gas and electricity networks actively working together.

Shift demand / production

1. Shifting demand with ‘big’ loads (heating [could include incentivising thermal stores], EVs)
2. Shifting demand with other ‘smaller’ loads. Could include lighting with in-built batteries; incentivising use of appliances at different times etc.
3. Using distributed (residential-scale) storage perhaps using storage that customers are putting in together with PV systems.
4. Shifting micro CHP operation e.g. to obtain voltage support (or avoid voltage levels being exceeded) when required.

Variants include:

- Incentivise (including behavioural DR) or automate
- Purely for DNO needs or also considering wider electricity system (i.e. managing conflicts, and DNO to DSO)
- Using internet-of-things approach; possibly working with aggregators / super-aggregators.

Community energy

1. Support heat networks with central heat pump (and energy store) instead of individual systems

The potential range of customer side measures to reduce the network impact of electrification of heat

Introducing customer side of the meter measures could enable ENWL to manage, and in some cases significantly reduce, the impact of electric heating uptake on its network

- ▶ There is a wide range of 'customer side measures' that ENWL could implement that will reduce the impact of heat pump uptake on its network, as summarised on the previous slide.
- ▶ Some of these measures focus on heating (such as interventions that reduce overall demand for heat in dwellings or interventions that focus on more efficient heating systems) – which we summarise below. These have been grouped into five core themes.
- ▶ On the following slides, we prioritise a short list of these customer side measures to drill down into in more detail. For each of these prioritised measures, we assess the impact these interventions will have on our heat pump load profiles and identify the scale of the benefit of deploying these interventions to ENWL (via identifying the reduction in the impact on its network from heat pump uptake if each intervention is applied).

A. Reduce the demand for peak heat

1. Additional building insulation
2. Advanced heating controls to reduce overall demand

B. More efficient electric heating

1. Larger capacity heat pump to reduce direct electric.
2. Ground source heat pump / high eff. heat pump
3. Better heat pump sizing & system design

C. Multiple energy sources

1. Incentivise hybrid heat pump
 1. Keep existing boiler if working
 2. Connected to gas grid / fuel tank
 3. Connected to LPG bottle
2. Self-generation (PV, micro CHP etc.)

D. Shift the demand for peak heat

1. Control strategies
 1. Better control of the heat pump to run smoother / flatter
 2. Pre-heating to reduce the maximum load
 3. Pre-heating to bring forward the max. load
 4. Over-heating to smooth the peak
 5. Wider comfort band
2. Energy storage
 1. Thermal store to take heat pump operation away from peak
 2. Increase thermal mass of the building
 3. Electric battery storage to shift operation away from peak

E. Avoid other players shifting demand to DNO peaks ("Avoiding conflicts")

1. "No-go" time zone for shifting HP operation
2. Shift to capacity charges for DNOs
3. Critical peak DuoS / time of use DuoS

Short listed customer side measures that will be assessed in more depth

Customer side of the meter measures could enable ENWL to manage, and in some cases significantly reduce, the impact of electric heating uptake on its network

- ▶ Below, we summarise at a high level, the customer side measures that will be assessed in more detail, and the high level action that ENWL would need to carry out to deliver this measure.
- ▶ These are the measures that are likely to deliver significant reductions in the level of investment required in ENWL's network by 2050.

No.	Customer side measure	Description
A1	Additional insulation	ENWL could fund, support, or deliver insulation improvements to homes that are installing electric heating or heat pumps.
B1	Larger heat pump to reduce direct electric heating	ENWL could subsidise the fully installed cost of heat pumps to encourage home owners to install a larger capacity unit – meaning more of the heating demand of the dwelling is supplied by the more efficient heat pump, rather than by the less efficient back up heater.
B2	Higher efficiency heat pump	ENWL could subsidise the fully installed cost of heat pumps to encourage home owners to install systems with the highest COPs (or via supporting installer training to ensure high quality installations) – meaning the annual efficiency of heat pump system is higher.
C1	Incentivise hybrids	ENWL could raise awareness of hybrids, provide cash-back type incentives for customers to install hybrids (or to retain their boilers). They could also compensate customers for 'lost' RHI revenue.
C2	Self-generation micro-CHP	ENWL could raise awareness of micro CHP & provide cash-back type incentives for customers to replace boilers with micro CHP.
D1	Shift heat pump operation with control strategies	ENWL could encourage the use of smarter controls and buffer tanks, provide cash-back type incentives for heat pump customers to install (larger) buffer tanks. This may require customer sacrificing some internal space for hot water tanks which ENWL could offer additional cash back / compensation for.
D2	Shift heat pump operation with energy storage	ENWL could encourage the use of battery storage, provide cash-back type incentives for heat pump customers to install batteries. It could also compensate customers for signing-up to schemes allow ENWL to control / influence battery operation (i.e. DNO demand response shifting).

Modelling customer side measures to reduce the impact of electric heating on ENWL's network

Customer side of the meter measures could enable ENWL to manage, and in some cases significantly reduce, the impact of electric heating uptake on its network

- Below we summarise, at a high level, the key changes we have made to our assumptions & heat pump load profiles when implementing a customer side measure. We also indicate the level of reduction that each measures on the impact of heat pump uptake on ENWL's network (under our reference and high heat pump uptake scenarios).

No.	Customer side measure	Key changes that have been applied to deliver this measure	Reduction in number of network interventions – reference uptake	Reduction in number of network interventions – high uptake
A1	Additional insulation	Solid wall insulation added to 1900s terraced and 1930s detached dwellings. Cavity wall added to 1950s semi detached dwellings. Loft insulation in all dwellings maxed out.	Low	Moderate
B1	Larger heat pump to reduce direct electric heating	The capacity of HT & LT ASHPs in semi detached dwellings was increased from 6.5kW to 7.5kW and 8.5kW. Capacity of back up heater reduced accordingly.	Low – moderate (but this has only been applied to one third of HP uptake)	Moderate
B2	Higher efficiency heat pump	The average COP of all heat pumps in existing dwellings was increased by 0.5 – 0.75.	Low – moderate	Low – moderate
C1	Incentivise hybrids	Uptake of ASHPs in semi detached dwellings was reduced in the reference and high scenarios. These are replaced by an increased uptake of hybrids.	High	High
C2	Self-generation from PV, micro-CHP	A 4 kW PV system was added to all dwellings with a heat pump. A 1kW micro CHP was modelled alongside every heat pump installed.	Low – moderate	Low – moderate
D1	Shift heat pump operation with control strategies	Additional hot water storage & sophisticated controls are introduced to all dwellings, enabling heat pump load to be shifted to before the morning heating period and during the afternoon set back period.	High	High
D2	Shift heat pump operation with energy storage	A 2kW (6kWh) battery storage system installed alongside all heat pumps. (Note – this has the same effect on load profiles as customer measure D1).	High	High

Comparison of the impact of different customer side measures: Number of network interventions required by time period

Cumulative number of network interventions required (by end of time period) when different customer side measures are introduced on ENWL's network – assuming our **reference scenario** uptake rate for heat pumps, and that the network is planned for a '1 in 20' peak winter day.

	2022	2030	2050	% change by 2050
<i>Reference scenario (with no customer side measure applied)</i>	439	1,320	3,808	Base
Customer measure A1: increasing the level of insulation of all dwellings	297	1,214	3,492	-8%
Customer measure B1: installing higher capacity heat pumps (only for LT & HT ASHP)	307	1,214	3,569	-6%
Customer measure B2: installing higher efficiency heat pumps (for all HP house types)	297	1,320	3,711	-3%
Customer measure C1: incentivise hybrid uptake rather than ASHP uptake	42	521	2,725	-28%
Customer measure C2: micro CHP installed alongside heat pumps	251	1,313	3,530	-7%
Customer measure D1: shifting HP operation with control strategies	42	632	2,725	-28%
Customer measure D2: battery storage installed alongside heat pumps	42	632	2,725	-28%

Cumulative number of network interventions required (by end of time period) when different customer side measures are introduced on ENWL's network – assuming our **high scenario** uptake rate for heat pumps, and that the network is planned for a '1 in 20' peak winter day.

	2022	2030	2050	% change by 2050
<i>High scenario (with no customer side measure applied)</i>	2,604	8,273	21,482	Base
Customer measure A1: increasing the level of insulation of all dwellings	1,748	6,269	16,738	-22%
Customer measure B1: installing higher capacity heat pumps (only for LT & HT ASHP)	1,006	6,244	13,391	-38%
Customer measure B2: installing higher efficiency heat pumps (for all HP house types)	1,605	7,348	21,434	-1%
Customer measure C1: incentivise hybrid uptake rather than ASHP uptake	64	1,318	7,616	-65%
Customer measure C2: micro CHP installed alongside heat pumps	1,748	6,775	18,281	-15%
Customer measure D1: shifting HP operation with control strategies	64	1,318	6,578	-69%
Customer measure D2: battery storage installed alongside heat pumps	64	1,318	6,578	-69%

Comparison of the impact of different customer side measures: Avoided cost from fewer upgrades required by time period

Avoid investment costs for ENWL's LV network (by end of time period) when different customer side measures are introduced on ENWL's network – assuming our **reference scenario** uptake rate for heat pumps, on a '1 in 20' peak winter day.

Values are in £ millions	2022	2030	2050
<i>Investment required in the network under the reference scenario</i>	21	121	339
Customer measure A1: increasing the level of insulation of all dwellings	3	2	73
Customer measure B1: installing higher capacity heat pumps (only for LT & HT ASHP)	14	73	65
Customer measure B2: installing higher efficiency heat pumps (for all HP house types)	3	-1	1
Customer measure C1: incentivise hybrid uptake rather than ASHP uptake	20	106	222
Customer measure C2: micro CHP installed alongside heat pumps	11	2	6
Customer measure D1: shifting HP operation with control strategies	20	103	222
Customer measure D2: battery storage installed alongside heat pumps	20	103	222

Avoid investment costs for ENWL's LV network (by end of time period) when different customer side measures are introduced on ENWL's network – assuming our **high scenario** uptake rate for heat pumps, on a '1 in 20' peak winter day.

Values are in £ millions	2022	2030	2050
<i>Investment required in the network under the high scenario</i>	287	965	3,306
Customer measure A1: increasing the level of insulation of all dwellings	95	302	595
Customer measure B1: installing higher capacity heat pumps (only for LT & HT ASHP)	175	301	2,358
Customer measure B3: installing higher efficiency heat pumps (for all HP house types)	98	285	-72
Customer measure C1: incentivise hybrid uptake rather than ASHP uptake	285	940	3,148
Customer measure C2: micro CHP installed alongside heat pumps	95	294	379
Customer measure D1: shifting HP operation with control strategies	285	940	3,170
Customer measure D2: battery storage installed alongside heat pumps	285	940	3,170

A framework to evaluate the range of customer side measures that ENWL could implement

Customer side of the meter interventions could enable ENWL to manage and in some cases significantly reduce the impact of electric heating uptake on its network

- ▶ In order to assess the overall benefit and suitability of each of the 'customer interventions' to ENWL, we have developed a high level framework for comparing each of the interventions.
- ▶ This framework is summarised below.

1. Customer impact

Does it enable & empower customers, giving them more choice? And help ENWL improve customer satisfaction

- Does it directly lower bills through either:
 - ▶ Reduced consumption
 - ▶ Benefiting from time-of-use tariffs (when introduced)
- Does it impact comfort?
- Does it impact convenience?
- Is there a significant 'customer hassle factor'?

2. Benefits for the wider electricity system

- Does it also bring benefits to electricity traders and to the system operator?
 - ▶ At all times?
 - ▶ Or at times might it work against the interests of the wider electricity system? If so how frequently at to what extent?

3. Impact, and certainty of impact

- How much peak load reduction will it bring?
 - ▶ Per house
 - ▶ Across the network
- How much certainty does ENWL have that peak demand will be reduced?
 - ▶ For example can customers or others over-ride the desired response?

4. Cost and delivery

- What is the cost of reducing the peak?
- How straightforward is the delivery for ENWL?

5. Carbon emissions

- To what degree does it reduce or increase carbon emissions?

Comparing customer interventions to reduce electric heating impact

By comparing the costs of implementing customer side measures to the reduction in network investment costs, a number of measures could be cost effective – which ENWL could exploring further or develop projects around.

- ▶ Having assessed (at a very high level) the cost of implementing different customer side measures, and using the Transform Model to understand the avoided network investment costs to 2050 from applying the different customer side measures, **three** measures appear 'cost effective' for ENWL to consider further / develop projects to build a deeper understanding. These are: **adding additional insulation** to dwellings installing heat pumps; funding the **installation of larger capacity heat pumps**; and encouraging the **installation of hybrid heat pumps rather than ASHPs**.
- ▶ Below, we summarise the performance of each customer side measure against key criteria. On the following slides, we provide more detail on each of these options.

Customer side measure	Cost to ENWL by 2050 of applying measure	Avoided network costs by 2050 by applying measure	Cost effectiveness (for high scenario)	Cost savings for customers (per year)	Customer impact (hassle, comfort)	Electricity system impact	Certainty of impact	Ease of delivery of measure for ENWL	Carbon impact
A1: Additional insulation	£215 M (ref) £569 M (high)	£73 M (ref) £595 M (high)		Low £100s					
B1: Larger heat pump to reduce direct electric heating	£361 M (ref) £724 M (high)	£65 M (ref) £2.4 B (high)		Minimal					
B2: Ground source / high efficiency heat pump	£174 M (ref) £464 M (high)	£1 M (ref) -£72 M (high)		Low £100s					
C1: Incentivise hybrids	Difficult to quantify	£222 M (ref) £3.1 B (high)		Minimal - £10s more expensive					
C2: Self-generation from micro-CHP	£4.3 B (ref) £10.4 B (high)	£6 M (ref) £379 M (high)		Zero					
D1: Shift heat pump operation with control strategies	£300 M (ref) £3 B (high)	£222 M (ref) £3.2 B (high)		Lower if 'off peak' tariff is available					
D2: Shift heat pump operation with energy storage	£2.2 B (ref) £5.8 B (high)	£222 M (ref) £3.2 B (high)		Lower if 'off peak' tariff is available					

Impact Potential



Assessment of customer side measures to reduce electric heating impact

A1 Additional insulation measures

Overall, this is a relatively low cost measure to introduce, that can deliver a significant reduction in the investment costs that ENWL would need to make in its network by 2050. However, it is only cost effective under the high scenario

Loft and cavity wall insulation is likely to be delivered under (energy supplier) obligations, although current rates (particularly for cavity wall) have slowed dramatically. Solid wall insulation is substantially below the Committee on Climate Change's required trajectory. ENWL could bring additionality on solid wall deployment in its area, and possibly on cavity wall insulation. We have modelled loft insulation being increased in all dwellings, with cavity wall insulation being added to all 1950s semi detached dwellings & solid wall insulation being added to all 1900s terraced dwellings and 1930s detached dwellings.

ENWL could fund, support, or deliver insulation improvements to homes that are installing electric heating

1. Customer impact - positive

Lower bills	Yes – but this will be marginal
Impact comfort	Better comfort
Impact on convenience	No impact
Customer hassle	Hassle during insulation installation, but then none

2. Benefits for the wider electricity system

Reduces peak heat demand and therefore works in interests of the whole electricity system – and with key aspects of government energy policy.

3. Impact, and certainty of impact

Peak load reduction / hh*	1-2.5 kW (depending on home, and thus the level of insulation upgrade compared to base-case)
Reduction in interventions under ref. scenario	~300 fewer interventions required by 2050 (an 8% reduction).
Certainty	Relatively high – only uncertainty relates to increased comfort leading to same peak demand if customer use their heating system more.

4. Cost and delivery

Cost per hh*	Ranges from ~£250 for cavity wall in small homes up to ~£800 for solid wall in large homes.
Total cost to ENWL to implement measure	£214 million (reference) £569 million (high)
Avoided cost of upgrading network by 2050	£73 million (reference) £595 million (high)
Delivery challenge for ENWL	High if managing directly – or reduce using contracts / partnerships

5. Carbon emissions

Reduces hh energy consumption and carbon emissions by 5 – 10 %

Assessment of customer side measures to reduce electric heating impact

A1 Additional insulation measures

Headlines on the impact of insulating dwellings in ENWL's region on the impact of electric heating on the network

- ▶ Little impact is observed. This is likely due to the reduction in energy demand, rather than the actual peak demand in most households for the reference case.

Cumulative number of network interventions before and after the customer side measure is applied during a '1 in 20' winter peak (reference scenario)

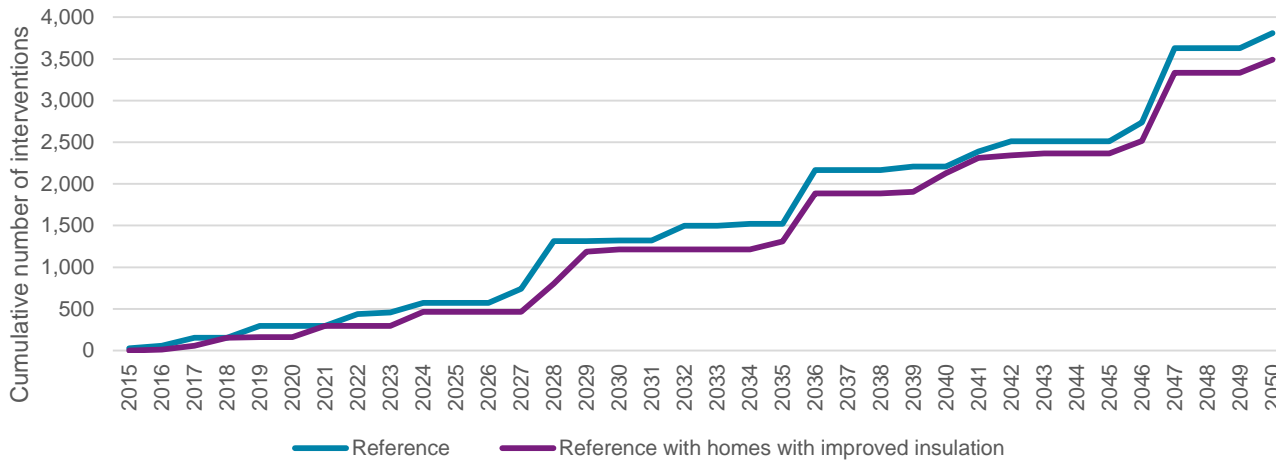

Reference scenario

Key changes made for this customer intervention:

- ▶ Loft insulation for all existing dwellings increased to 250mm
- ▶ Cavity wall insulation added to 1950s semi detached dwellings, with external wall insulation added to 1900s terraces and 1930s detached dwellings
- ▶ No additional insulation added to new builds.
- ▶ Increasing insulation levels typically reduces the duration of peak demand (and in some cases significantly reduces peak demand), but a similar peak load in most heat pumps house types still occurs when first getting the dwellings to heat up.

Effect of insulating dwellings on the impact heat pump uptake has on ENWL's network at the LV feeder level:

Cumulative <u>number of network interventions</u>	2022	2030	2050
Reference	439	1,320	3,808
Reference with homes with improve insulation	297	1,214	3,492

Cumulative <u>investment required on the LV network (£)</u>	2022	2030	2050
Reference	21,065,655	121,287,973	339,247,037
Reference with homes with improve insulation	18,379,012	119,575,532	266,568,766
Avoided cost to ENWL by introducing this measure	2,686,643	1,712,441	72,678,271

Overall reduction in number of interventions by 2050:

8%

Overall reduction in investment required by 2050:

£73 million

'1 in 20' winter peak

Assessment of customer side measures to reduce electric heating impact

A1 Additional insulation measures

Headlines on the impact of insulating dwellings in ENWL's region on the impact of electric heating on the network

- ▶ Significant impact from 2030 onwards. With a large number of homes forecasted to adopt ASHPs in the high scenario, improving insulation in all households leads to a reduced duration of the peak demand, which results in a reduced DNO level peak due to diversification of heat pump operation.

Cumulative number of network interventions before and after the customer side measure is applied (high scenario)

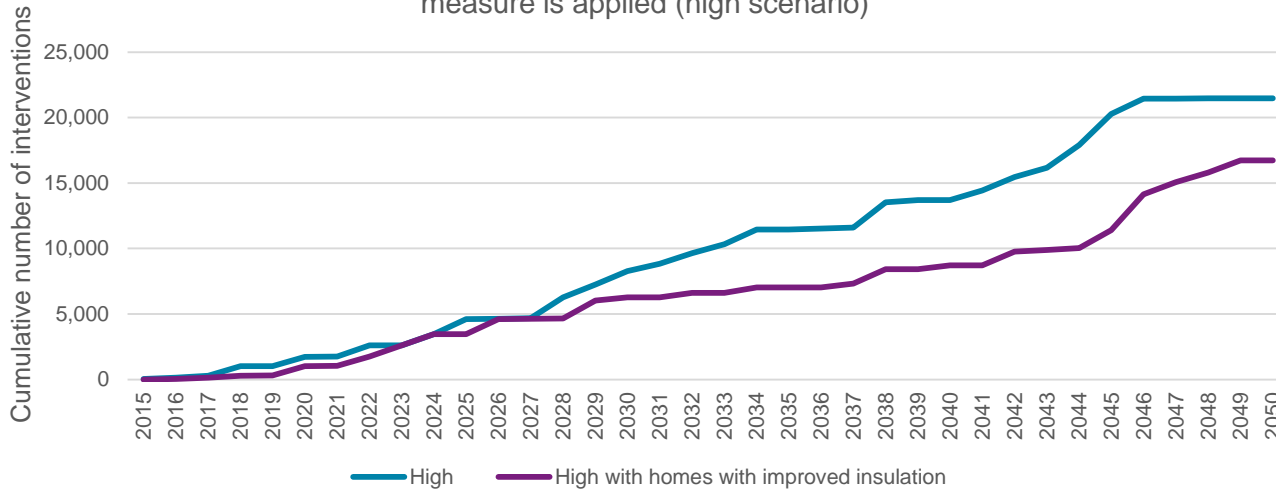

High scenario

Key changes made for this customer intervention:

- ▶ Loft insulation for all existing dwellings increased to 250mm
- ▶ Cavity wall insulation added to 1950s semi detached dwellings, with external wall insulation added to 1900s terraces and 1930s detached dwellings
- ▶ No additional insulation added to new builds.
- ▶ Increasing insulation levels typically reduces the duration of peak demand (and in some cases significantly reduces peak demand), but a similar peak load in most heat pumps house types still occurs when first getting the dwellings to heat up.

Effect of insulating dwellings on the impact heat pump uptake has on ENWL's network at the LV feeder level:

Cumulative <u>number of network interventions</u>	2022	2030	2050
High	2,604	8,273	21,482
High with homes with improve insulation	1,748	6,269	16,738

Cumulative <u>investment</u> required on the LV network (£)	2022	2030	2050
High	286,599,054	965,429,542	3,306,468,898
High with homes with improve insulation	192,091,917	663,190,341	2,711,183,925
Avoided cost to ENWL by introducing this measure	94,507,137	302,239,201	595,284,973

Overall reduction in number of interventions by 2050:

22%

Overall reduction in investment required by 2050:

£595 million

'1 in 20' winter peak

Assessment of customer side measures to reduce electric heating impact

B1 Larger heat pump to reduce direct electric heating

A relatively expensive measure per house hold to implement (targeted only at semi detached dwellings installing ASHPs) with modest avoided costs occurring under the reference scenario. If the high uptake rate of heat pumps occurs, this measure could see huge avoided network costs for ENWL at the LV distribution network level.

Heat pumps today are typically sized to meet 90 – 95% of the heat load on the coldest days of the year, with a back up electric heater being used (only on the coldest days) to cover the peak. This reduces the capacity of the heat pump required, lowering the upfront cost faced by customers – currently a big barrier to uptake.

ENWL could subsidise the fully installed cost of heat pumps to encourage home owner to install a larger capacity unit – meaning the less efficient back up heater is used less.

1. Customer impact - positive

<i>Lower bills</i>	Yes, but this will be a marginal reduction and will depend on the number of 'peak' days in a winter. Increased load on 'average' winter days could offset some of this saving.
<i>Impact comfort</i>	No impact
<i>Impact on convenience</i>	No impact
<i>Customer hassle</i>	Low – will require a larger outdoor unit to be installed so customer may have to sacrifice some further external space.

2. Benefits for the wider electricity system

Can reduce peak heat demand considerably as the heat pump (which is more efficient) displaces operation of the back up electric heater on the coldest days.

3. Impact, and certainty of impact

<i>Peak load reduction / hh</i>	1 – 2 kW (achieve by increasing HP size from 6.5kW to 7.5 – 8.5kW) on peak winter days. Peak load increases slightly on average winter days.
<i>Reduction in interventions under ref. scenario</i>	Number of interventions on network reduces by 5 - 10% to 2050 (~250 fewer interventions).
<i>Certainty</i>	High certainty of reductions occurring on peak winter days due to HP operating steadily (at a higher output), displacing back up operation.

4. Cost and delivery

<i>Cost per hh</i>	~£1,000 – 1,500 per heat pump
<i>Total cost to ENWL to implement measure</i>	~£361 million (reference) ~£724 million (high)
<i>Avoided cost of upgrading network by 2050</i>	£65 million (reference) £2.4 billion (high)
<i>Delivery challenge for ENWL</i>	ENWL would need to deliver subsidies to customers, or set up partnerships directly with installers to reduce the price charged to customers. Risk around installers inflating prices to customers.

5. Carbon emissions

Marginal reduction in carbon emissions.

Assessment of customer side measures to reduce electric heating impact

B1 Larger heat pump to reduce direct electric heating

Headlines on the impact of increasing the capacity of heat pumps being installed on the network

- In general very little impact on a reduction in the total number of required interventions.

Cumulative number of network interventions before and after the customer side measure is applied (reference scenario)

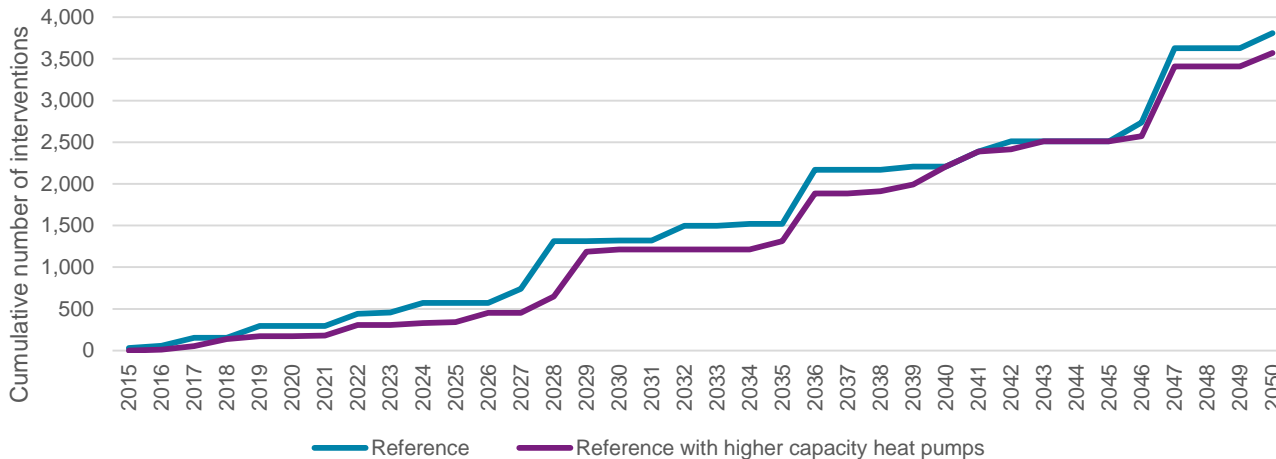

Reference scenario

Key changes made for this customer intervention:

- For the ASHPs installed, the capacity of the heat pump was increased from 6.5kW to 7.5 – 8.5kW (for LT and HT HPs respectively).
- This had the effect that reductions in peak demand would occur on peak winter days due to HP operating steadily (at a higher output), displacing back up operation.
- However, peak load increases slightly on average winter days, where the backup heater would not be used anyway.

‘1 in 20’ winter peak

Effect of installing larger capacity heat pumps on ENWL’s network at the LV feeder level:

Cumulative <u>number of network interventions</u>	2022	2030	2050
Reference	439	1,320	3,808
Reference with larger capacity LT & HT ASHPs	307	1,214	3,569

Cumulative <u>investment required on the LV network (£)</u>	2022	2030	2050
Reference	21,065,655	121,287,973	339,247,037
Reference with larger capacity LT & HT ASHPs	6,989,257	48,131,379	273,771,175
Avoided cost to ENWL by introducing this measure	14,076,399	73,156,594	65,475,863

Overall reduction in number of interventions by 2050:

6%

Overall reduction in investment required by 2050:

£65 million

Assessment of customer side measures to reduce electric heating impact

B1 Larger heat pump to reduce direct electric heating

Headlines on the impact of increasing the capacity of heat pumps being installed on the network

- ▶ Significant impact from 2030 onwards.
- ▶ Reduction in peak load demand by 1-2 kW per household has a sizeable impact in the high scenario due to the large number of ASHPs installed on the network.

Cumulative number of network interventions before and after the customer side measure is applied (high scenario)

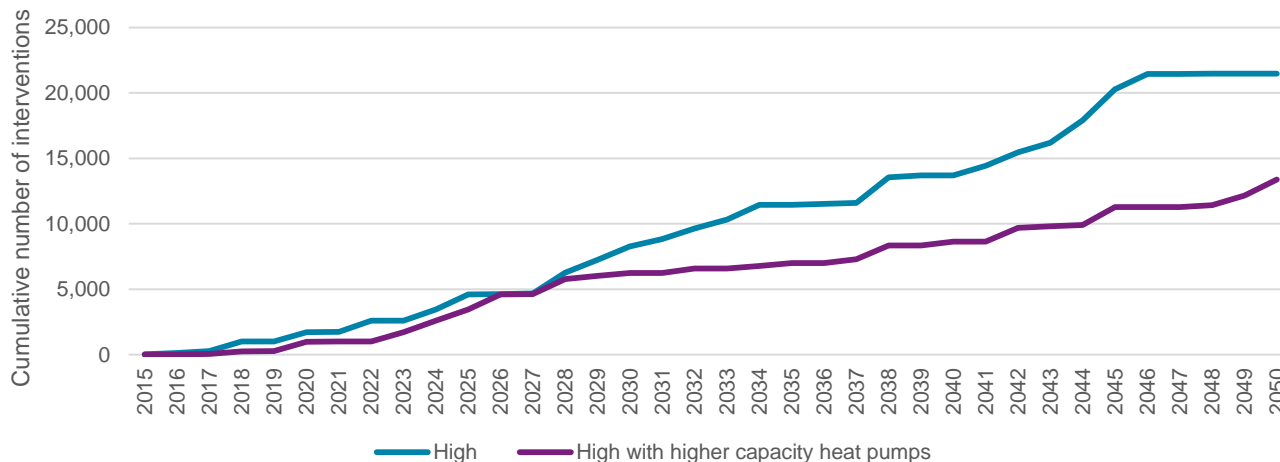

High scenario

Key changes made for this customer intervention:

- ▶ For the ASHPs installed, the capacity of the heat pump was increased from 6.5kW to 7.5 – 8.5kW (for LT and HT HPs respectively).
- ▶ This had the effect that reductions in peak demand would occur on peak winter days due to HP operating steadily (at a higher output), displacing back up operation.
- ▶ However, peak load increases slightly on average winter days, where the backup heater would not be used anyway.

‘1 in 20’ winter peak

Effect of installing larger capacity heat pumps on ENWL’s network at the LV feeder level:

Cumulative <u>number of network interventions</u>	2022	2030	2050
High	2,604	8,273	21,482
High with larger capacity LT & HT ASHPs	1,006	6,244	13,391

Cumulative <u>investment</u> required on the LV network (£)	2022	2030	2050
High	286,599,054	965,429,542	3,306,468,898
High with larger capacity LT & HT ASHPs	111,107,425	663,949,088	948,611,618
Avoided cost to ENWL by introducing this measure	175,491,629	301,480,454	2,357,857,280

Overall reduction in number of interventions by 2050:

38%

Overall reduction in investment required by 2050:

£2.4 billion

Assessment of customer side measures to reduce electric heating impact

B2 Higher efficiency heat pump to reduce electricity consumption

One of the least expensive measures (with no hassle at all for the customer) for ENWL to implement, but this delivers minimal network and financial benefit to ENWL out to 2050. Under the high scenario, investments in the network in the short term (by 2030) are deferred, which actually results in higher costs being occurred in the 2030 – 2050 period.

Heat pumps today vary in quality and efficiency (COP), with the more expensive, high end products being more efficient than the most commonly installed and widely available heat pumps (e.g. Daikin, Mitsi).

ENWL could subsidise the fully installed cost of heat pumps to encourage home owner to install systems with the highest COPs (or via supporting installer training to ensure high quality installations) – meaning the annual efficiency is higher.

1. Customer impact - positive

Lower bills	Yes – of the order of £100 - £200 per dwelling
Impact comfort	No impact
Impact on convenience	No impact
Customer hassle	Low – will require a larger outdoor unit to be installed so customer may have to sacrifice some further external space.

2. Benefits for the wider electricity system

Can reduce peak heat demand considerably as the heat pump (which is more efficient) displaces operation of the back up electric heater on the coldest days.

3. Impact, and certainty of impact

Peak load reduction / hh	0.6 kW (achieve by increasing HP efficiency; 0.75 improvement in COP in HT HPs and 0.5 improvement in COP in LT HPs) on most days
Reduction in interventions under ref. scenario	Reduced by ~100 interventions by 2050; a 3% reduction
Certainty	High certainty of reductions occurring on peak winter days due to HP operating steadily (at a higher output), displacing back up operation.

4. Cost and delivery

Cost per hh	~£250-550 per heat pump
Total cost to ENWL to implement measure	~£174 million (reference) ~£464 million (high)
Avoided cost of upgrading network by 2050	£1 million (reference) -£72 million (high)
Delivery challenge for ENWL	ENWL would need to set up a way of delivering subsidies to customers, or partnerships directly with installers to reduce the price charged to customers for a more efficient heat pump.

5. Carbon emissions

Significant reductions in CO2 emissions possible (~20%). As electricity decarbonises out to 2050, this saving disappears.

Assessment of customer side measures to reduce electric heating impact

B2 Higher efficiency heat pump to reduce electricity consumption

Headlines on the impact of installing higher efficiency heat pumps on the network

- ▶ In general very little impact on a reduction in the total number of required interventions.
- ▶ Whilst having little impact on peak demand, higher efficiency heat pumps would reduce the total electricity consumed by households with heat pumps installed.

Cumulative number of network interventions before and after the customer side measure is applied (reference scenario)

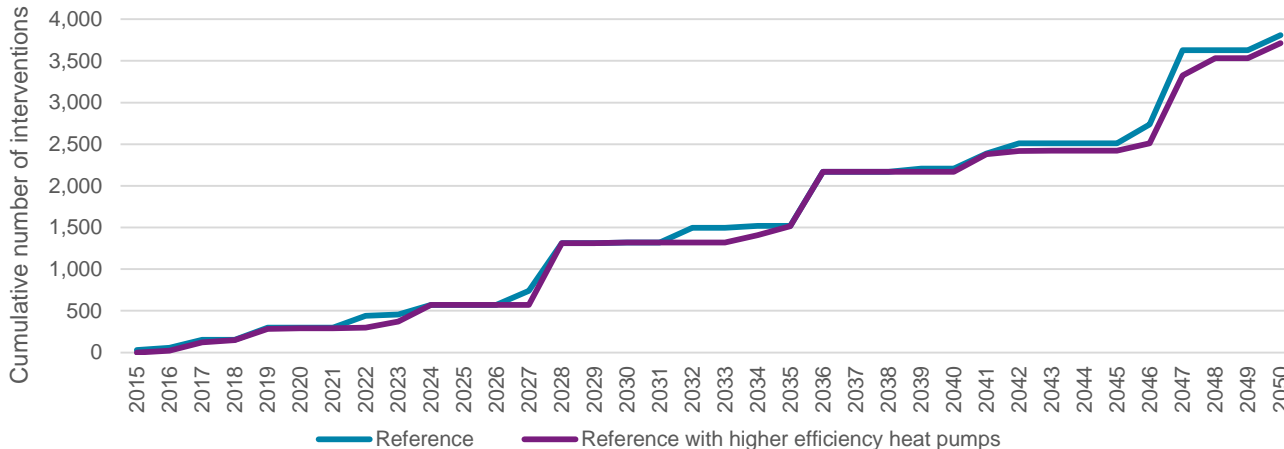

Reference scenario

Key changes made for this customer intervention:

- ▶ We increased the COP of heat pumps as follows
 - ▶ For HT ASHPs: an increase in average COP of 0.75
 - ▶ For LT ASHPs: an increase in average COP of 0.5
- ▶ The main impact this had was improving the overall operating efficiency of all heat pumps installed, which reduced total energy consumption.
- ▶ As the rated capacities of the heat pumps did not change, this did not reduce the overall peak demand of the heat pumps, but did reduce the duration for which they were required to run to meet heating demands.

Effect of installing higher efficiency heat pumps on ENWL's network at the LV feeder level:

Cumulative <u>number of network interventions</u>	2022	2030	2050
Reference	439	1,320	3,808
Reference with higher efficiency heat pumps	297	1,320	3,711

Cumulative <u>investment required on the LV network (£)</u>	2022	2030	2050
Reference	21,065,655	121,287,973	339,247,037
Reference with higher efficiency heat pumps	18,279,579	121,914,660	338,196,062
Avoided cost to ENWL by introducing this measure	2,786,076	- 626,687	1,050,976

Overall reduction in number of interventions by 2050:

3%

Overall reduction in investment required by 2050:

£1 million

‘1 in 20’ winter peak

Assessment of customer side measures to reduce electric heating impact

B2 Higher efficiency heat pump to reduce electricity consumption

Headlines on the impact of installing higher efficiency heat pumps on the network

- ▶ Overall, installing higher efficiency heat pumps only has a minor impact on the number of interventions required on the LV network.
- ▶ We see fewer major ground works being carried out by 2030, with most of this work being delayed until the 2030s & 2040s which results in more expensive ground works occurring later, which actually drives up the overall investment in the network required by ENWL.

Cumulative number of network interventions before and after the customer side measure is applied (high scenario)

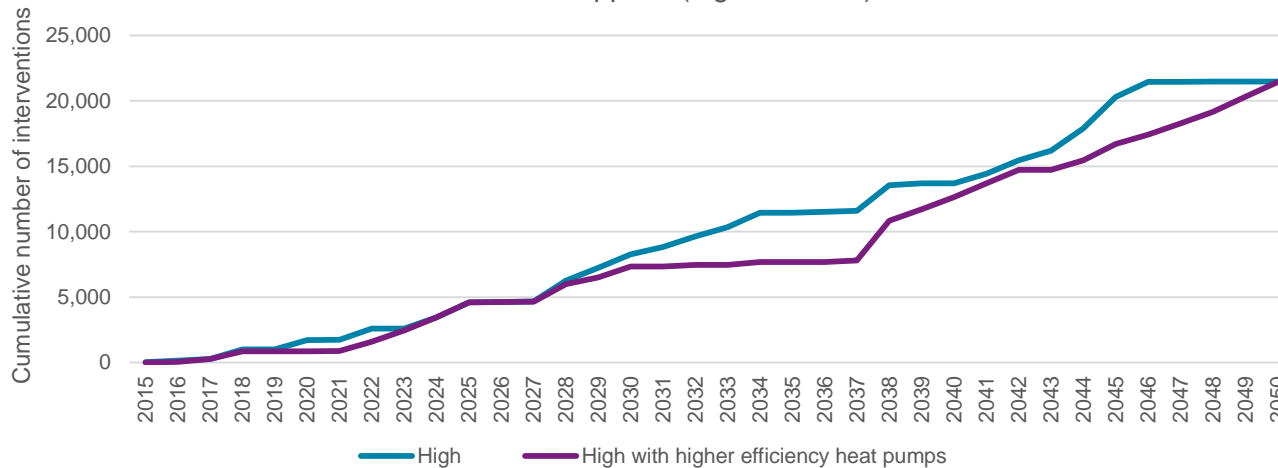

High scenario

Key changes made for this customer intervention:

- ▶ We increased the COP of heat pumps as follows
 - ▶ For HT ASHPs: an increase in average COP of 0.75
 - ▶ For LT ASHPs: an increase in average COP of 0.5
- ▶ The main impact this had was improving the overall operating efficiency of all heat pumps installed, which reduced total energy consumption.
- ▶ As the rated capacities of the heat pumps did not change, this did not reduce the overall peak demand of the heat pumps, but did reduce the duration for which they were required to run to meet heating demands.

Effect of installing higher efficiency heat pumps on ENWL's network at the LV feeder level:

Cumulative <u>number of network interventions</u>	2022	2030	2050
High	2,604	8,273	21,482
High with higher efficiency heat pumps	1,605	7,348	21,434

Cumulative <u>investment</u> required on the LV network (£)	2022	2030	2050
High	286,599,054	965,429,542	3,306,468,898
High with higher efficiency heat pumps	188,394,030	680,914,581	3,378,689,473
Avoided cost to ENWL by introducing this measure	98,205,024	284,514,961	-72,220,575

Overall reduction in number of interventions by 2050:

<1%

Overall reduction in investment required by 2050:

-£72 million

‘1 in 20’ winter peak

Assessment of customer side measures to reduce electric heating impact

C1 Incentivise hybrid uptake

Potentially the lowest cost customer side measure to implement, delivering significant reductions in the impact on the network and a huge reduction in the investment required in the network. The challenge will be in encouraging customers to opt for a hybrid heat pump rather than a full electric ASHP. This may work against the 'decarbonisation of heat' as it will extend the use of gas to 2050.

A small number of gas and oil hybrids are on the market, but far less than full electric heat pumps. Although hybrids are often cheaper than full electric heat pumps, customers may not install them as they are unaware of them, or wish to move fully away from gas or oil heating. Customers with working gas or oil boilers could also be incentivised to retain these boilers for peak demand days. Different approaches to hybrids are possible e.g. the boiler can be used just to shave peaks or the boiler can operate for longer periods of time as outside temperature falls.

ENWL could raise awareness of hybrids; provide cash-back type incentives for customers to install hybrids or to retain boilers. ENWL could also compensate customers for 'lost' RHI revenue.

1. Customer impact - complex

<i>Lower bills</i>	Complex: marginally lower if avoid inefficient HP operation on cold days; but perhaps higher if e.g. oil prices high and lose RHI payments and customer has to pay gas standing charge.
<i>Impact comfort</i>	No impact (possibly positive during very cold days)
<i>Impact on convenience</i>	No impact (assuming intelligent control)
<i>Customer hassle</i>	Small – needs to maintain gas / oil connection, possibly a larger appliance

2. Benefits for the wider electricity system

Reduces peak heat demand and therefore works in interests of the whole electricity system.

3. Impact, and certainty of impact

<i>Peak load reduction / hh</i>	For each ASHP displaced, we will see a reduction in load of 2 – 3kW on '1 in 20' peak days and of -0.5 – 1 kW on 'average' peak days.
<i>Reduction in interventions under ref. scenario</i>	~1,100 fewer network interventions (a 28% reduction)
<i>Certainty</i>	High – unless customer disables / alters control system

4. Cost and delivery

<i>Cost per hh</i>	Difficult to quantify. ~£100 – 200 of 'lost' RHI income from installing a hybrid vs an ASHP. Low £100s for subsidies / marketing campaigns.
<i>Total cost to ENWL to implement measure</i>	Difficult to assess (marketing campaign, offering incentives to customers)
<i>Avoided cost of upgrading network by 2050</i>	£222 million (reference) £3.1 billion (high)
<i>Delivery challenge for ENWL</i>	Relatively low – can deliver through well-designed incentives

5. Carbon emissions

Depends on control strategy – assuming electricity is de-carbonising then will lead to some increase in carbon emissions

Assessment of customer side measures to reduce electric heating impact

C1 Incentivise hybrid uptake

Key changes made to the uptake rates of pure electric heat pumps versus hybrid heat pumps under this customer measure

- ▶ In the reference scenario, all **HT ASHP in a semi** become **hybrid heat pump in a semi**. A share of **LT ASHP in a semi** is shifted to **hybrid heat pump in a semi** (with the clustering assumptions for **hybrid heat pump in a semi** changing slightly to ensure the distribution of heat pumps on the different feeder types of network overall remains the same).
- ▶ In the high scenario, we apply a similar approach.
- ▶ In the table below, we illustrate the breakdown of the uptake of ASHPs and hybrid heat pumps under the original reference & high scenarios, and the reference & high scenarios once we apply the customer side measure.

Scenario	ASHP uptake rate in 2050	Hybrid uptake rate in 2050	Total heat pump uptake	% ASHP	% hybrid
Reference	288,616	145,863	434,479	66%	34%
Reference C1	182,346	252,133	434,479	42%	58%
High	667,632	490,483	1,158,115	58%	42%
High C1	205,689	952,426	1,158,115	18%	82%

Assessment of customer side measures to reduce electric heating impact

C1 Incentivise hybrid uptake

Headlines on the impact of installing hybrid heat pumps rather than pure electric heat pumps on the network

- ▶ Quite a sizeable impact is achievable by incentivising hybrid heat pumps over ASHPs. Impact is especially pronounced after 2035.
- ▶ Whilst this would reduce the peak demand (and overall electricity consumption) it would likely increase carbon emissions due to increased gas use.

Cumulative number of network interventions before and after the customer side measure is applied (reference scenario)

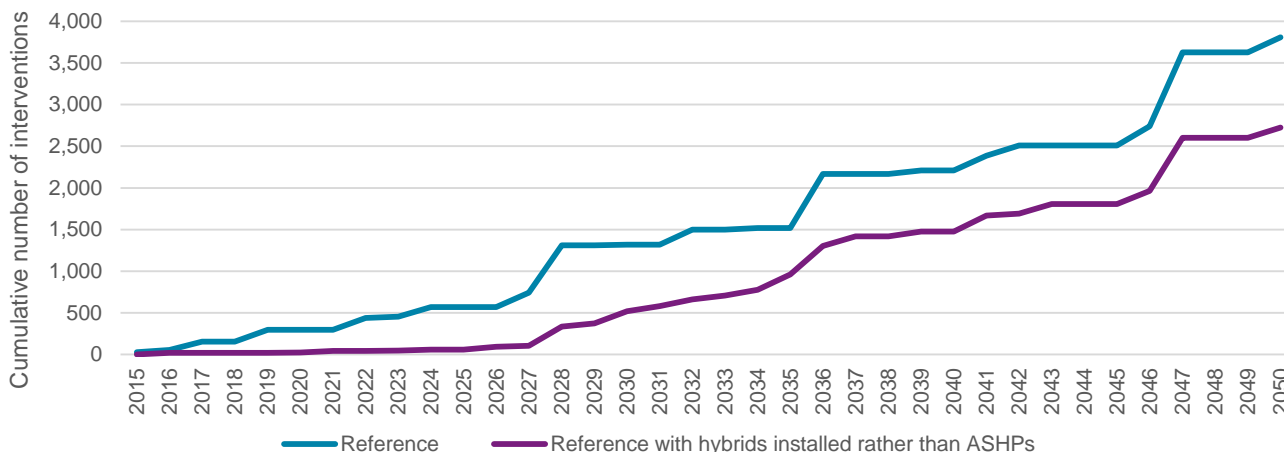

Reference scenario

Key changes made for this customer intervention:

- ▶ For those homes initially forecasted to adopt ASHPs, it was assumed that incentivisation of hybrid HPs would cause some of them to adopt hybrid HPs instead of ASHPs.
- ▶ The main impact this had was during winter peak heating periods when the outside dry bulb air temperature dropped below 0 degrees Celsius, fewer heat pumps would be running (as hybrids run in gas-boiler-only mode at these temperatures).

‘1 in 20’ winter peak

Effect of installing hybrid heat pumps rather than pure electric heat pumps on ENWL’s network at the LV feeder level:

Cumulative <u>number of network interventions</u>	2022	2030	2050
Reference	439	1,320	3,808
Reference with hybrids being installed rather than ASHPs	42	521	2,725

Cumulative <u>investment required on the LV network (£)</u>	2022	2030	2050
Reference	21,065,655	121,287,973	339,247,037
Reference with hybrids being installed rather than ASHPs	836,176	15,066,231	116,958,565
Avoided cost to ENWL by introducing this measure	20,229,480	106,221,742	222,288,472

Overall reduction in number of interventions by 2050:

28%

Overall reduction in investment required by 2050:

£222 million

Assessment of customer side measures to reduce electric heating impact

C1 Incentivise hybrid uptake

Headlines on the impact of installing hybrid heat pumps rather than pure electric heat pumps on the network

- ▶ A very large impact is achievable by incentivising hybrid heat pumps over ASHPs. Impact is especially pronounced almost immediately, from 2021 onwards.
- ▶ Whilst this would reduce the peak demand (and overall electricity consumption) it would likely increase carbon emissions due to increased gas use.

Cumulative number of network interventions before and after the customer side measure is applied (high scenario)

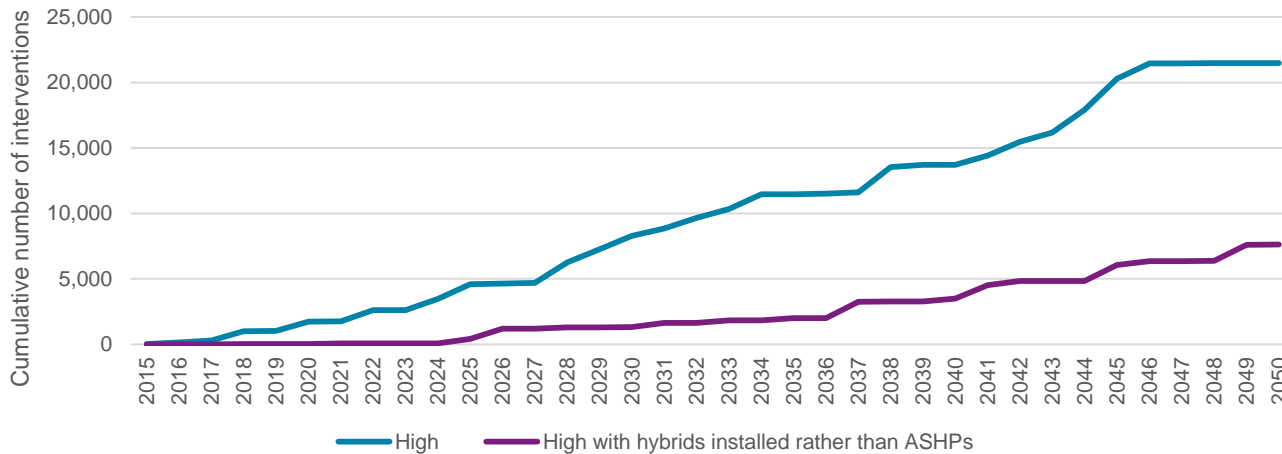

High scenario

Key changes made for this customer intervention:

- ▶ For those homes initially forecasted to adopt ASHPs, it was assumed that incentivisation of hybrid HPs would cause some of them to adopt hybrid HPs instead of ASHPs.
- ▶ The main impact this had was during winter peak heating periods when the outside dry bulb air temperature dropped below 0 degrees Celsius, fewer heat pumps would be running (as hybrids run in gas-boiler-only mode at these temperatures).

Effect of installing hybrid heat pumps rather than pure electric heat pumps on ENWL's network at the LV feeder level:

Cumulative <u>number of network interventions</u>	2022	2030	2050
High	2,604	8,273	21,482
High with hybrids being installed rather than ASHPs	64	1,318	7,616

Cumulative <u>investment</u> required on the LV network (£)	2022	2030	2050
High	286,599,054	965,429,542	3,306,468,898
High with hybrids being installed rather than ASHPs	1,191,035	25,752,412	158,732,305
Avoided cost to ENWL by introducing this measure	285,408,019	939,677,130	3,147,736,593

Overall reduction in number of interventions by 2050:

65%

Overall reduction in investment required by 2050:

£3.1 billion

‘1 in 20’ winter peak

Assessment of customer side measures to reduce electric heating impact

C2 Distributed generation (Micro CHP)

A very expensive & potentially challenging customer side measure to introduce for little gain. Like with heat pumps, awareness of micro CHP is low, so convincing customers to install this will be challenging.

If micro CHP were to be scaled-up to a large extent amongst the predominantly gas-connected customer base (1 system for every 1 HP system), the electricity generated by these systems could be fed to households in the same area that are operating HPs, reducing strain on the wider network. However, despite the potential for successful uptake in the residential sector, there has been little uptake to-date of micro CHP in the UK (predominantly due to cost).

ENWL could raise awareness of micro CHP; provide cash-back type incentives for customers to replace boilers with micro CHP.

1. Customer impact - complex

<i>Lower bills</i>	Complex: potentially increased gas bills due to need to export generated electricity to HP households; but would likely be lowered sizeably if a power-purchase arrangement were established between micro CHP households and those with HPs (due to the current spark spread).
<i>Impact comfort</i>	No impact
<i>Impact on convenience</i>	No impact
<i>Customer hassle</i>	Medium – needs to maintain gas, ensure suitable electronics are installed for electricity export, and maintain a more complex, expensive heating system.

2. Benefits for the wider electricity system

Reduces peak electricity demand for heat pumps by roughly 1kW (electric output of micro CHP) heat demand and provides small benefits to the whole electricity system.

3. Impact, and certainty of impact

<i>Peak load reduction / hh</i>	1 kW
<i>Reduction in interventions under ref. scenario</i>	Reduced by ~280 interventions; a 7% reduction
<i>Certainty</i>	Medium – dependent on non-HP customers running their heating systems at peak heating times

4. Cost and delivery

<i>Cost per hh</i>	~£10,000
<i>Total cost to ENWL to implement measure</i>	~£4.3 billion (ref) ~£10.4 billion (high)
<i>Avoided cost of upgrading network</i>	~£6 million (ref) ~£380 million (high)
<i>Delivery challenge for ENWL</i>	High – costly, invasive and difficult to gain customer buy-in

5. Carbon emissions

Assuming electricity is de-carbonising, then this could lead to an increase in carbon emissions due to increased electricity generation from gas via micro CHP.

Assessment of customer side measures to reduce electric heating impact

C2 Distributed generation (Micro CHP)

Headlines on the impact of installing distributed generation (micro CHP) alongside heat pumps on the network

- ▶ In general very little impact for the cost and difficulty of the intervention (£2,873,538 per intervention reduction in the reference case). Impact only occurs after 2035.
- ▶ Installation of 1 micro CHP system for every 1 HP would result in a reduction of **1,512 interventions (13% decrease)** in the reference scenario.

Cumulative number of network interventions before and after the customer side measure is applied (reference scenario)

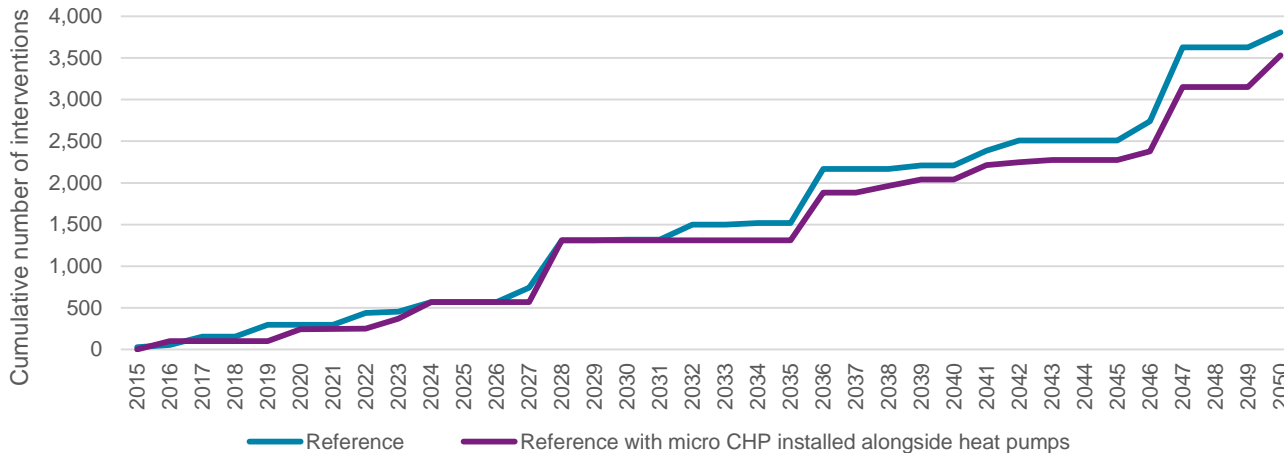

Reference scenario

Key changes made for this customer intervention:

- ▶ For every HP installed on the network, a micro CHP system was installed as a replacement for a gas-boiler using home.
- ▶ The micro CHP system had a peak output of 1 kWe.
- ▶ The micro CHP system was assumed to follow the same operational profile as a gas boiler i.e. 0530-0930, 1500-2230.
- ▶ All electricity produced by the micro CHP system was assumed to be consumed by a HP in the neighbourhood.

‘1 in 20’ winter peak

Effect of installing micro CHP alongside heat pumps on the cumulative number of network interventions at the LV feeder level:

Cumulative <u>number of network interventions</u>	2022	2030	2050
Reference	439	1,320	3,808
Reference with micro CHP installed alongside heat pumps	251	1,313	3,530

Cumulative <u>investment required on the LV network (£)</u>	2022	2030	2050
Reference	21,065,655	121,287,973	339,247,037
Reference with micro CHP installed alongside heat pumps	9,913,495	119,254,364	332,761,195
Avoided cost to ENWL by introducing this measure	11,152,161	2,033,609	6,485,843

Overall reduction in number of interventions by 2050:

7%

Overall reduction in investment required by 2050:

£ 6 million

Assessment of customer side measures to reduce electric heating impact

C2 Distributed generation (Micro CHP)

Headlines on the impact of installing distributed generation (micro CHP) alongside heat pumps on the network

- ▶ Significant impact from 2030 onwards.
- ▶ Despite significant impact, the cost and difficulty of the intervention makes it prohibitive (£2,067,324 per intervention reduction in the high case).
- ▶ Installation of 1 micro CHP system for every 1 HP would result in a reduction of **5,602 interventions 23% decrease** in the high scenario

Cumulative number of network interventions before and after the customer side measure is applied (high scenario)

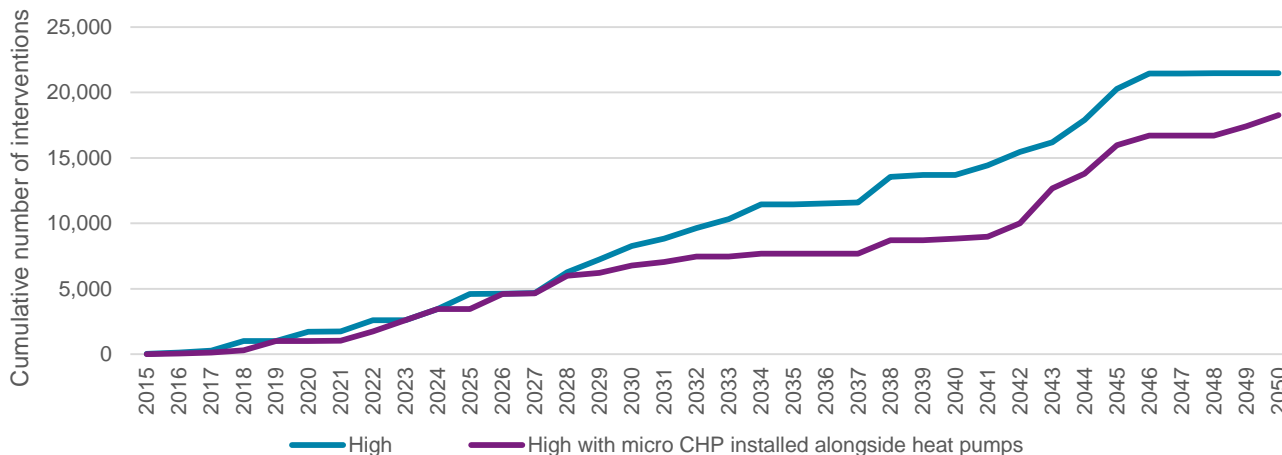

High scenario

Key changes made for this customer intervention:

- ▶ For every HP installed on the network, a micro CHP system was installed as a replacement for a gas-boiler using home.
- ▶ The micro CHP system had a peak output of 1 kW_e.
- ▶ The micro CHP system was assumed to follow the same operational profile as a gas boiler i.e. 0530-0930, 1500-2230.
- ▶ All electricity produced by the micro CHP system was assumed to be consumed by a HP in the neighbourhood.

‘1 in 20’ winter peak

Effect of installing micro CHP alongside heat pumps on the cumulative number of network interventions at the LV feeder level:

Cumulative <u>number of network interventions</u>	2022	2030	2050
High	2,604	8,273	21,482
High with micro CHP installed alongside heat pumps	1,748	6,775	18,281

Cumulative <u>investment</u> required on the LV network (£)	2022	2030	2050
High	286,599,054	965,429,542	3,306,468,898
High with micro CHP installed alongside heat pumps	191,585,079	670,950,717	2,927,284,708
Avoided cost to ENWL by introducing this measure	95,013,975	294,478,825	379,184,190

Overall reduction in number of interventions by 2050:

15%

Overall reduction in investment required by 2050:

£ 379 million

Assessment of customer side measures to reduce electric heating impact

D1 Shift heat pump operation with control strategies

A very expensive & potentially challenging customer side measure to introduce – but the avoided network costs are significant (£100s millions - £ billions). The level of investment required to deliver this customer side measure is slightly lower than the avoided network upgrade costs, so this could be an intervention worth considering. The hassle associated with installing buffer tanks in all customer's homes – and customer willingness to give up space in their home – could be a significant barrier for ENWL to overcome.

Improved control strategies using smarter heating/heat pump controls in combination with thermal storage in the form of a buffer tank could play a sizeable role in mitigating electricity demand from heat pumps. If a buffer tank were installed alongside every heat pump, the heating demand could be met at peak times by the buffer tank rather than the heat pump. The heat pump could then charge the buffer tank (and pre-heat the house) during times of lower demand.

ENWL could encourage the use of smarter controls and buffer tanks; provide cash-back type incentives for HP customers to install (larger) buffer tanks.

1. Customer impact - low

<i>Lower bills</i>	Dependent on customer's tariff. Running the HP during cheaper off-peak periods and drawing from buffer tank storage during peak periods could reduce customers' electricity bills.
<i>Impact comfort</i>	No impact (HP would revert to grid electricity when buffer tanks are depleted)
<i>Impact on convenience</i>	No impact (assuming intelligent control)
<i>Customer hassle</i>	Small – needs to maintain system

2. Benefits for the wider electricity system

Reduces peak electricity demand, can also provide a sink for intermittent generation from renewables, and therefore works in interests of the whole electricity system.

3. Impact, and certainty of impact

<i>Peak load reduction / hh</i>	2 kW
<i>Reduction in interventions under ref. scenario</i>	Reduced by ~1,100 interventions; a 28% reduction
<i>Certainty</i>	High – unless customer drastically changes heat use behaviour

4. Cost and delivery

<i>Cost per hh</i>	~£100s
<i>Total cost to ENWL to implement measure</i>	~£300 million (ref) ~£3 billion (high)
<i>Avoided cost of upgrading network</i>	~£222 million (ref) ~£3.2 billion (high)
<i>Delivery challenge for ENWL</i>	High – invasive and difficult to gain customer buy-in

5. Carbon emissions

Likely to have little impact (compared to reference scenario). It may slightly reduce emissions by not using the grid at peak times (i.e. no peaker plants).

Assessment of customer interventions to reduce electric heating impact

D1 Shift heat pump operation with control strategies

Headlines on the impact of improved heat pumps control strategies on the network

- ▶ Significant impact, especially after 2025.
- ▶ Installation of 1 buffer tank & sophisticated controls for every 1 HP would result in a reduction of **3,217 interventions 28% decrease**) in the reference scenario

Cumulative number of network interventions before and after the customer side measure is applied (reference scenario)

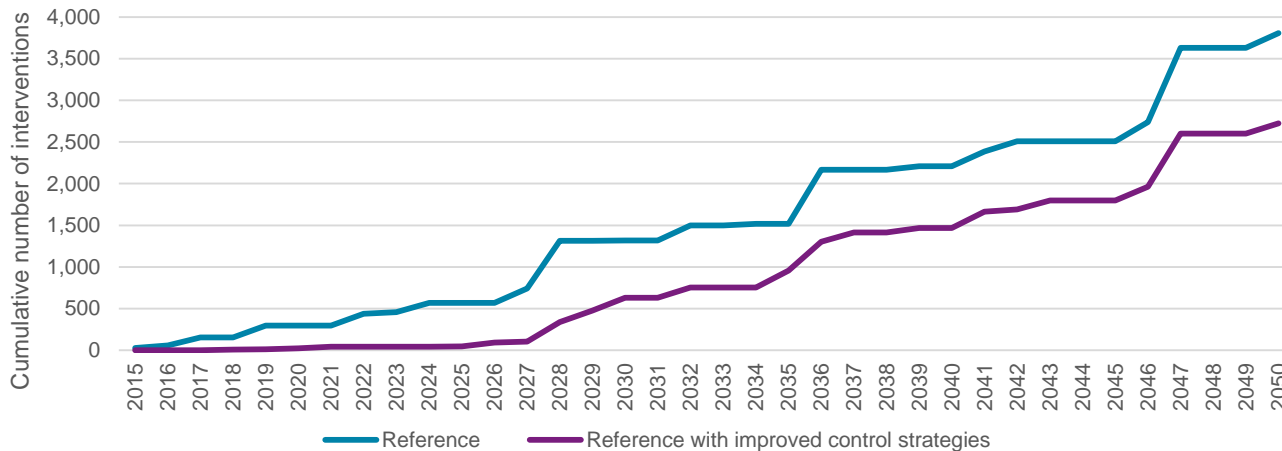

Reference scenario

Key changes made for this customer intervention:

- ▶ For every HP installed on the network, a (larger) buffer tank system was installed in the same household.
- ▶ The buffer tank was assumed to provide thermal output at peak heating times (0600-0930 & 1600-1900) and charge outside these times (0930-1530 & 2300-0600).
- ▶ In addition to charging the buffer tank during off-peak periods, the heat pump control strategy was assumed to also pre-heat the thermal mass of the house.

‘1 in 20’ winter peak

Effect of improved heat pump control strategies on the cumulative number of network interventions at the LV feeder level:

Cumulative <u>number of network interventions</u>	2022	2030	2050
Reference	439	1,320	3,808
Reference with buffer tanks installed alongside heat pumps	42	632	2,725

Cumulative <u>investment</u> required on the LV network (£)	2022	2030	2050
Reference	21,065,655	121,287,973	339,247,037
Reference with buffer tanks installed alongside heat pumps	837,584	18,178,136	116,958,495
Avoided cost to ENWL by introducing this measure	20,228,071	103,109,837	222,288,543

Overall reduction in number of interventions by 2050:

28%

Overall reduction in investment required by 2050:

£222 million

Assessment of customer interventions to reduce electric heating impact

D1 Shift heat pump operation with control strategies

Headlines on the impact of improved heat pumps control strategies on the network

- ▶ Huge impact, especially after 2021.
- ▶ Installation of 1 buffer tank & sophisticated controls for every 1 HP would result in a reduction of **16,135 interventions (70% decrease)** in the high scenario. It should be noted that the overall number of required interventions in the high case is lower in 2050 than in the reference case. This is likely due to more early stage interventions being addressed in the high case (i.e. less actual interventions) which had carry-over impacts in TRANSFORM when moving towards 2050.

Cumulative number of network interventions before and after the customer side measure is applied (high scenario)

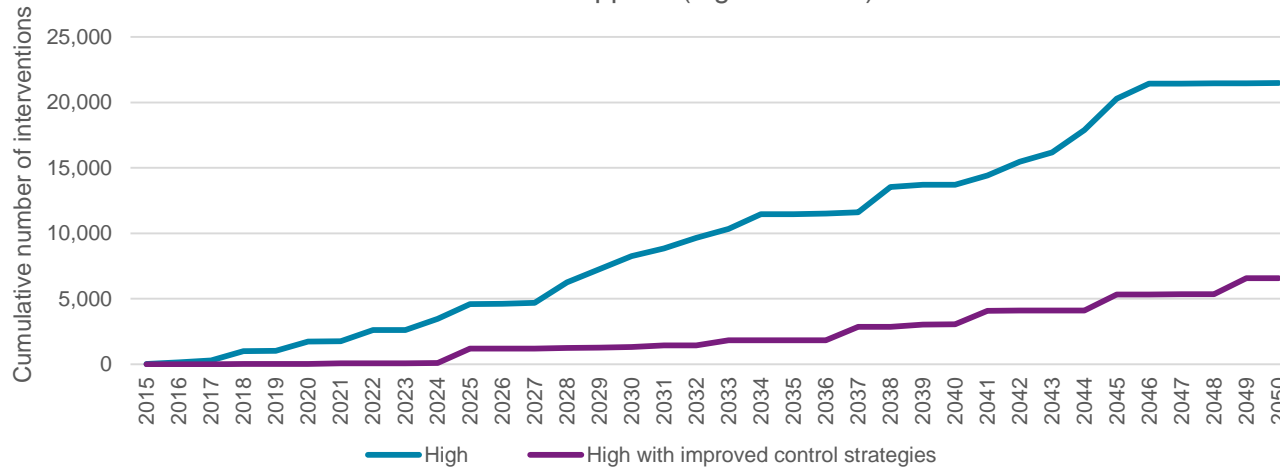

High scenario

Key changes made for this customer intervention:

- ▶ For every HP installed on the network, a (larger) buffer tank system was installed in the same household.
- ▶ The buffer tank was assumed to provide thermal output at peak heating times (0600-0930 & 1600-1900) and charge outside these times (0930-1530 & 2300-0600).
- ▶ In addition to charging the buffer tank during off-peak periods, the heat pump control strategy was assumed to also pre-heat the thermal mass of the house.

Effect of improved heat pump control strategies on the cumulative number of network inventions at the LV feeder level:

Cumulative <u>number of network interventions</u>	2022	2030	2050
High	2,604	8,273	21,482
High with buffer tanks installed alongside heat pumps	64	1,318	6,578

Cumulative <u>investment</u> required on the LV network (£)	2022	2030	2050
High	286,599,054	965,429,542	3,306,468,898
High with buffer tanks installed alongside heat pumps	1,191,697	25,661,357	136,753,157
Avoided cost to ENWL by introducing this measure	285,407,357	939,768,185	3,169,715,741

Overall reduction in number of interventions by 2050:

69%

Overall reduction in investment required by 2050:

£3.2 billion

‘1 in 20’ winter peak

Assessment of customer interventions to reduce electric heating impact

D2 Battery Storage (In-Home)

A very expensive & potentially challenging customer side measure to introduce – but the avoided network costs are significant (£100s millions - £ billions). However, upgrading the network may be the more cost effective option for ENWL unless there are additional revenue streams it can tap into to maximise the benefit of the high volumes of distributed storage assets.

Battery storage is increasingly being adopted in the residential sector, and could play a sizeable role in mitigating electricity demand from HPs. If a battery storage system were installed alongside every HP, the electricity demand of the HP could be met at peak times by the battery rather than the grid. The battery could then charge during off-peak/period of lower demand.

ENWL could encourage the use of battery storage; provide cash-back type incentives for HP customers to install batteries. They could also compensate customers for signing-up to controlled shifting to the battery (i.e. DNO demand response shifting).

1. Customer impact - low

<i>Lower bills</i>	Dependent on customer's tariff. Charging the battery during cheaper off-peak periods and running the HP from the battery during peak periods could reduce customers' electricity bills.
<i>Impact comfort</i>	No impact (HP would revert to grid electricity when battery charge is depleted)
<i>Impact on convenience</i>	No impact (assuming intelligent control)
<i>Customer hassle</i>	Small – needs to maintain battery

2. Benefits for the wider electricity system

Reduces peak electricity demand, can also provide a sink for intermittent generation from renewables, and therefore works in interests of the whole electricity system.

3. Impact, and certainty of impact

<i>Peak load reduction / hh</i>	2 kW
<i>Reduction in interventions under ref. scenario</i>	Reduced by ~1,100 interventions; a 28% reduction
<i>Certainty</i>	High – unless customer uses battery for non-HP electricity load

4. Cost and delivery

<i>Cost per hh</i>	~£5,000
<i>Total cost to ENWL to implement measure</i>	~£2.2 billion (ref) ~£5,8 billion (high)
<i>Avoided cost of upgrading network</i>	~£222 million (ref) ~£3.2 billion (high)
<i>Delivery challenge for ENWL</i>	High – costly, invasive and difficult to gain customer buy-in

5. Carbon emissions

Likely to have little impact (compared to reference scenario). It may slightly reduce emissions by not using the grid at peak times (i.e. no peaker plants).

Assessment of customer interventions to reduce electric heating impact

D2 Battery Storage (In-Home)

Headlines on the impact of installing battery storage alongside heat pumps on the network

- ▶ Significant impact, especially after 2025. Despite significant impact, the cost of the intervention could make it prohibitive (£2.2 billion in the reference case).
- ▶ Installation of 1 battery for every 1 HP would result in a reduction of **3,217 interventions 28% decrease** in the reference scenario

Cumulative number of network interventions before and after the customer side measure is applied (reference scenario)

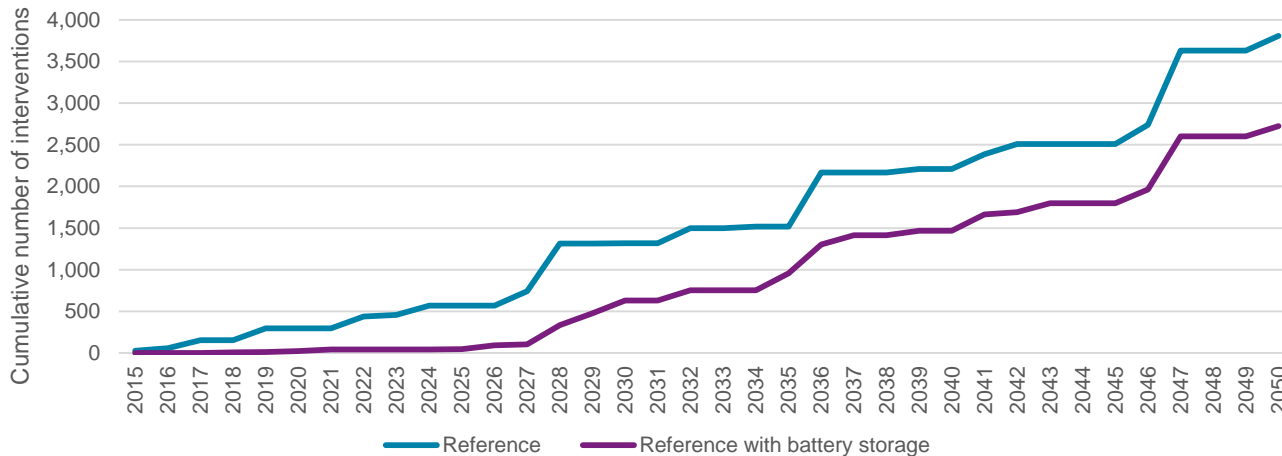

Reference scenario

Key changes made for this customer intervention:

- ▶ For every HP installed on the network, a battery storage system was installed in the same household.
- ▶ The battery system had a peak output of 2 kWe and a useable capacity of 6 kWh.
- ▶ The battery was assumed to provide output at peak heating times (0600-0930 & 1600-1900) and charge outside these times (0930-1530 & 2300-0600).
- ▶ It was assumed that within the defined periods all electricity provided by the battery was consumed by the heat pump.

‘1 in 20’ winter peak

Effect of installing batteries alongside heat pumps on the cumulative number of network interventions at the LV feeder level:

Cumulative <u>number of network interventions</u>	2022	2030	2050
Reference	439	1,320	3,808
Reference with batteries installed alongside heat pumps	42	632	2,725

Cumulative <u>investment</u> required on the LV network (£)	2022	2030	2050
Reference	21,065,655	121,287,973	339,247,037
Reference with batteries installed alongside heat pumps	837,584	18,178,136	116,958,495
Avoided cost to ENWL by introducing this measure	20,228,071	103,109,837	222,288,543

Overall reduction in number of interventions by 2050:

28%

Overall reduction in investment required by 2050:

£222 million

Assessment of customer interventions to reduce electric heating impact

D2 Battery Storage (In-Home)

Headlines on the impact of installing battery storage alongside heat pumps on the network

- ▶ Huge impact, especially after 2021. The cost of the intervention could potentially be prohibitive (£5.8 billion in the high case).
- ▶ Installation of 1 battery for every 1 HP would result in a reduction of **16,135 interventions (70% decrease)** in the high scenario. It should be noted that the overall number of required interventions in the high case is lower in 2050 than in the reference case. This is likely due to more early stage interventions being addressed in the high case (i.e. less actual interventions) which had carry-over impacts in TRANSFORM when moving towards 2050.

Cumulative number of network interventions before and after the customer side measure is applied (high scenario)

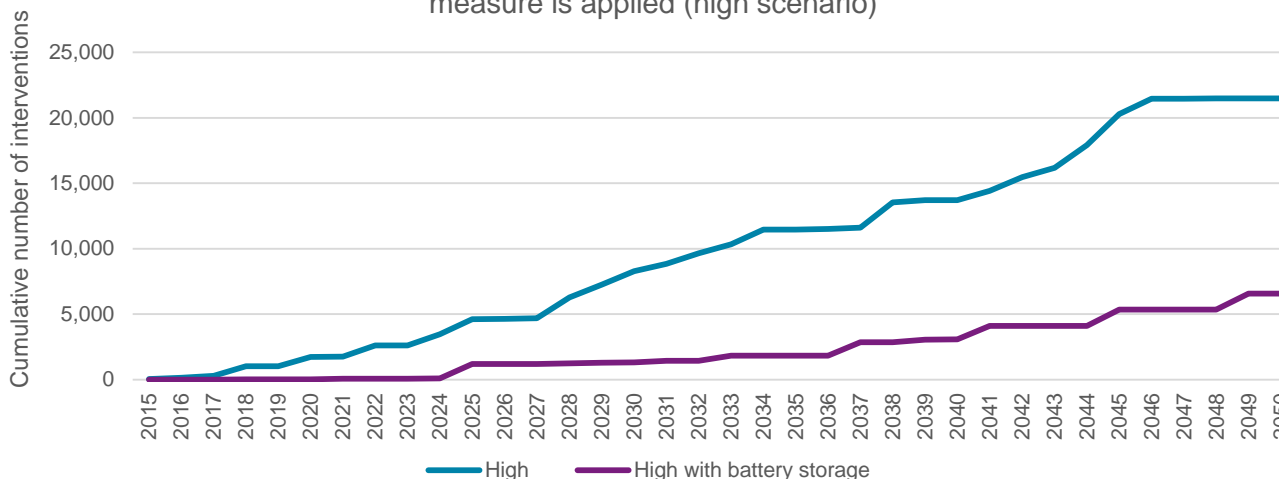

High scenario

Key changes made for this customer intervention:

- ▶ For every HP installed on the network, a battery storage system (2 kW_e peak output, capacity of 6 kWh) was installed in the same household.
- ▶ The battery was assumed to provide output at peak heating times (0600-0930 & 1600-1900) and charge outside these times (0930-1530 & 2300-0600).
- ▶ It was assumed that within the defined periods all electricity provided by the battery was consumed by the heat pump.

‘1 in 20’ winter peak

Effect of installing batteries alongside heat pumps on the cumulative number of network interventions at the LV feeder level:

Cumulative <u>number of network interventions</u>	2022	2030	2050
High	2,604	8,273	21,482
High with batteries installed alongside heat pumps	64	1,318	6,578

Cumulative <u>investment</u> required on the LV network (£)	2022	2030	2050
High	286,599,054	965,429,542	3,306,468,898
High with batteries installed alongside heat pumps	1,191,697	25,661,357	136,753,157
Avoided cost to ENWL by introducing this measure	285,407,357	939,768,185	3,169,715,741

Overall reduction in number of interventions by 2050:

69%

Overall reduction in investment required by 2050:

£3.2 billion

Executive Summary	4
Introduction & project scope	12
Overview of different heat pump technologies	14
▶ High level description of the different types of heat pump technologies	
▶ Technology costs, performance & 'fit' into different house types – current & future	
▶ Summary of housing stock in ENWL's region & defining the 6 heat pump – house type combinations	
High level overall methodology	22
Heat pump load profile outputs	24
▶ Methodology for developing granular & robust heat pump load profiles	
▶ Review of existing studies & projects measuring heat pump load profiles	
▶ Temperature profiles considered in this analysis & selection of outputs from our building physics modelling	
▶ Results from developing load profiles for different heat pumps in different house types	
Diversifying heat pump load profiles & clustering of heat pumps	32
▶ Overview of approach	
▶ Outputs of diversification of heat pump load profiles	
▶ Clustering assumptions for allocating different heat pump types to different LV feeder types	
Forecasting heat pump uptake rates and low-voltage distribution network impacts	44
▶ Developing the three scenarios for heat pump uptake on ENWL's network	
▶ Impact of heat pump uptake on ENWL's low-voltage distribution network – network interventions & cost of upgrading the network	
Optimisation of heat pump load profiles	69
▶ Overview of optimisation approach	
▶ Flexibility of HP operation	
▶ Outputs from Imperial's optimisation modelling – optimised load profiles	
▶ Impact of the optimised profiles on ENWL's network	
Customer side measure analysis	80
▶ Description of customer side measures & approach for assessing these measures	
▶ Analysis & quantification of reduction in the impact implementation of these measures have on ENWL's network	
Recommendations	111
Annexes	113

1. Consider planning the network for a '1 in 20' winter peak rather than an 'average' winter peak

Under the reference scenario for heat pump uptake in ENWL's region, during an 'average' winter peak in 2050, heat pumps will add almost 1 GW of new load at peak times. Under the high scenario (when half of homes in ENWL's region have a heat pump), this additional load becomes 2.5 GW. If we consider a '1 in 20' winter peak instead, this additional load increases to ~1.5 GW under the reference scenario for heat pump uptake, and increases to ~3.5 GW under the high scenario – a significant increase in load at peak times.

2. Explore further the impact that clustering of heat pump uptake could have on the LV network

In this analysis, 6 combinations of different heat pumps in different house types was considered. Uptake of different types of heat pumps will likely be concentrated by house type & by customer type (which was not explored). This will likely lead to parts of the LV network being overloaded more quickly than other parts, depending on the concentration of house types on certain feeders, the types of customers in these areas, and the level of loading already on feeders & transformers in these regions. Identifying these areas, understanding the likely uptake rates of heat pumps, and exploring how best to prepare for / influence heat pump uptake will help ENWL reduce the near term impact of electrification of heat on its LV network.

3. Develop projects / trials to explore the cost effectiveness of 'customer side measures' that could be implemented to manage and reduce the impact of heat pump uptake on the LV network

A number of 'customer side measures', that could reduce the peak load of heat pumps at the house hold level, were explored at a high level in this study. These involve engaging with customers / introducing measures into dwellings to influence the operation of heat pumps / reduce the peak load of heat pumps. Having assessed (at a very high level) the cost of implementing different measures and the impact these have on network investment costs to 2050, three measures appear 'cost effective' for ENWL to consider further / develop projects to build a deeper understanding of. These are: adding additional insulation to dwellings installing heat pumps; funding the installation of larger capacity heat pumps; and encouraging the installation of hybrid heat pumps rather than ASHPs.

4. Continue to engage with other energy stakeholders (e.g. National Grid & supply companies) to understand their challenges & priorities, at the system level, and how this may influence the operation of heat pumps and impacts on the distribution network

The analysis in this report shows that 'optimising' heat pump operation (to increase the use of lower cost electricity generation) will likely increase the overall load of heat pumps at peak time, and increase the investments required in the LV network by 2050. This may lead to tensions between customer side measures being introduced which support the national generation and distribution system, and those that support the local distribution network. It will therefore be important that decisions consider both scales of network, and that the wider economic impact is assessed.

Executive Summary	4
Introduction & project scope	12
Overview of different heat pump technologies	14
▶ High level description of the different types of heat pump technologies	
▶ Technology costs, performance & 'fit' into different house types – current & future	
▶ Summary of housing stock in ENWL's region & defining the 6 heat pump – house type combinations	
High level overall methodology	22
Heat pump load profile outputs	24
▶ Methodology for developing granular & robust heat pump load profiles	
▶ Review of existing studies & projects measuring heat pump load profiles	
▶ Temperature profiles considered in this analysis & selection of outputs from our building physics modelling	
▶ Results from developing load profiles for different heat pumps in different house types	
Diversifying heat pump load profiles & clustering of heat pumps	32
▶ Overview of approach	
▶ Outputs of diversification of heat pump load profiles	
▶ Clustering assumptions for allocating different heat pump types to different LV feeder types	
Forecasting heat pump uptake rates and low-voltage distribution network impacts	44
▶ Developing the three scenarios for heat pump uptake on ENWL's network	
▶ Impact of heat pump uptake on ENWL's low-voltage distribution network – network interventions & cost of upgrading the network	
Optimisation of heat pump load profiles	69
▶ Overview of optimisation approach	
▶ Flexibility of HP operation	
▶ Outputs from Imperial's optimisation modelling – optimised load profiles	
▶ Impact of the optimised profiles on ENWL's network	
Customer side measure analysis	80
▶ Description of customer side measures & approach for assessing these measures	
▶ Analysis & quantification of reduction in the impact implementation of these measures have on ENWL's network	
Recommendations	111
Annexes	113

Annex A: diversification factors at the DNO & national levels for different periods of the day for 'average' and '1 in 20' winter days

Period of day	Diversification % DNO level	Diversification % National level	Diversification % DNO level	Diversification % National level
Type of winter day	'Average' winter day	'Average' winter day	'1 in 20' winter day	'1 in 20' winter day
Morning heating period – peak period	85%	80%	90%	85%
Morning heating period – shoulder	85%	80%	90%	85%
Evening heating period – peak period	91%	86%	99%	94%
Evening heating period – shoulder	91%	86%	99%	94%
Set back	90%	86%	93%	88%
Night	95%	95%	95%	95%
Duration over which heating systems are switched on	2 hours	3 hours	2 hours	3 hours

Annex B: example load profiles on weekend days

Weekend versus week day profiles

Our assumptions on the timing of the heating period / periods differ between week days and weekend days. This is a key driver for variations in the heat pump load profiles on week days versus weekend days.

- ▶ During the week, we assume that homes need to be 'warm' between 07:00 – 09:00 and then from 16:00 – 23:00. With a lower 'set back' temperature that needs to be maintained in the middle of the day.
- ▶ At the weekend, the requirement for homes to be 'warm' is continuous from 07:00 – 23:00.

Load profiles for heat pump-house types on an 'average' winter day – weekend profiles

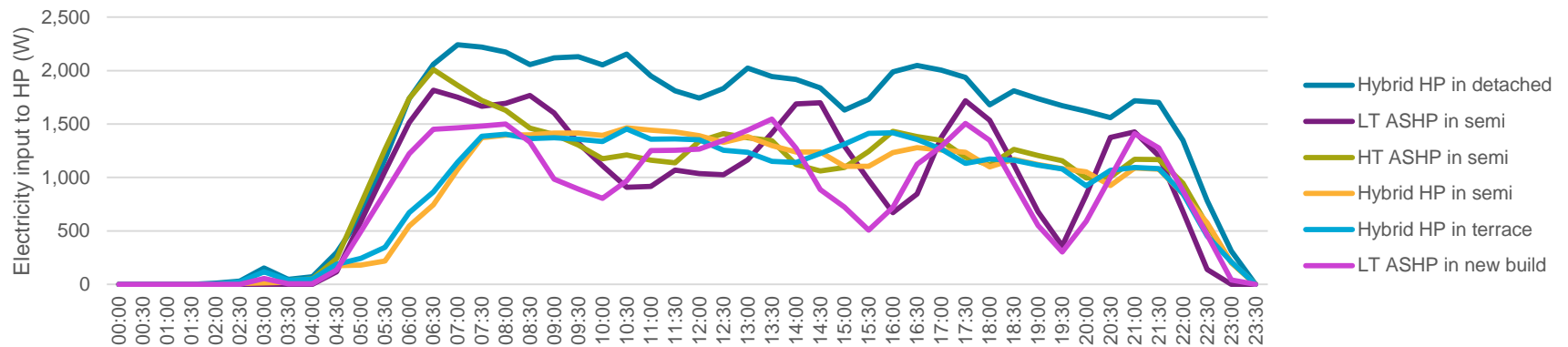

Load profiles for heat pump-house types on an '1 in 20' winter day – weekend profiles

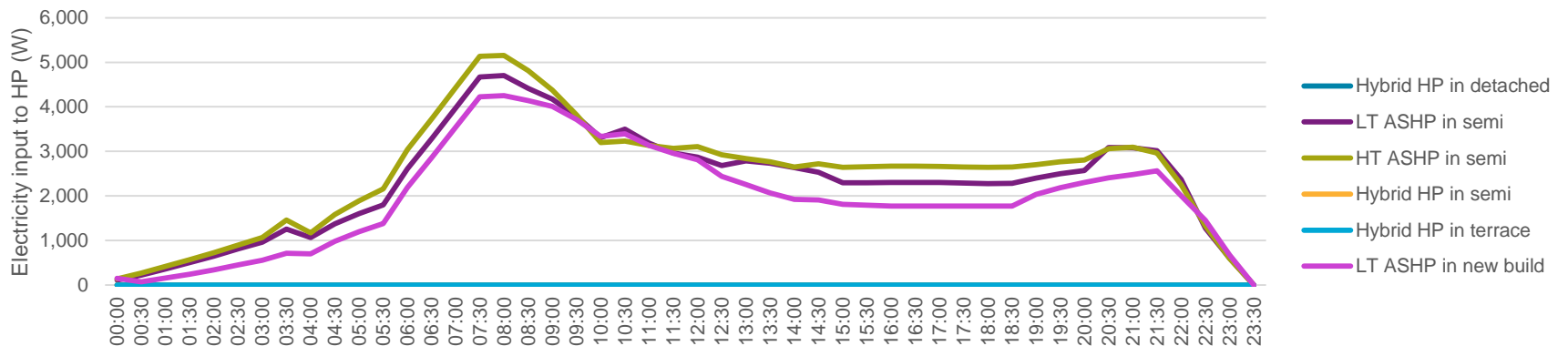

'Average' winter

'1 in 20' winter

Annex C: description of EA Technology's Transform Model that was used for modelling the LV network impact of heat pumps

High level description of the Transform Model

The Transform Model is a techno-economic tool to assess investment decisions in electricity distribution infrastructure that enable the cost-efficient and secure integration of low carbon technologies (LCTs) in the future low carbon energy systems. The Transform Model has been developed by EA Technology for the activities undertaken in the Smart Grid Forum. It has been extensively used by Distribution Network Operators (DNOs) as a network investment and planning tool to support the development of their business plans for the RIIO-ED1 regulatory period, which have been submitted to, and reviewed by, Ofgem. (Source- EATL)

The Transform network model is based on selecting an appropriate combination of generic network types, and thus indicates volumes and costs of particular types of network intervention over future decades, rather than being a tool to plan specific network interventions. The Transform Model used in this project was set up in the same way as the model used for Electricity North West's RIIO-ED1 business plan submission.

Annex D: System configurations simulated in the Building Physics model: Low- & High-Temperature All-Electric Heat Pump Installations

Heat Pump Capacity

Sized as 95-100% of building's design heat load

5kW or 6.5kW Heat Output
0% to 100% modulation range

In-line Heater Capacity

Acting as supplementary heater
- NOT a full backup for HP

3kW Heat Output
0% to 100% Modulation Range

Heat Pump + In-line Heater Mode

In-line Heater modulates to meet target flow temp

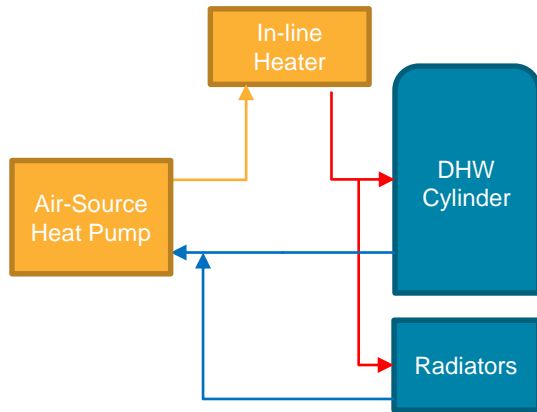

Selecting Operating Mode

Low- & High-Temperature Heat Pumps

Heat Pump + In-line Heater | Heat Pump Only

~0°C
Outside Air Temperature

Heat Pump Only Mode

In-line Heater is unused

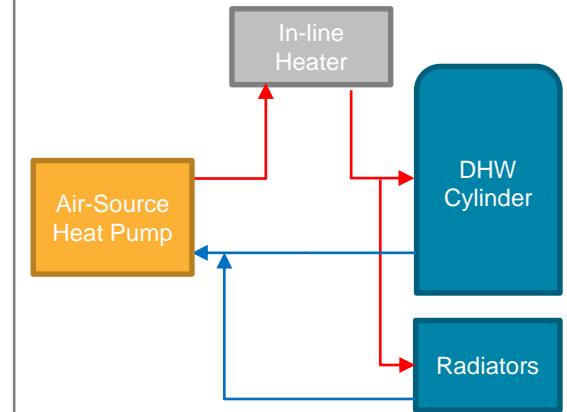

Optimised Start

HP Preheats building without In-line Heater

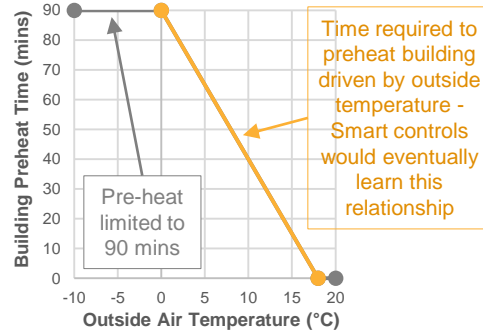

Weather Compensation

Non-Hybrid HPs use a single Target Flow Temp for Space Heating & HP

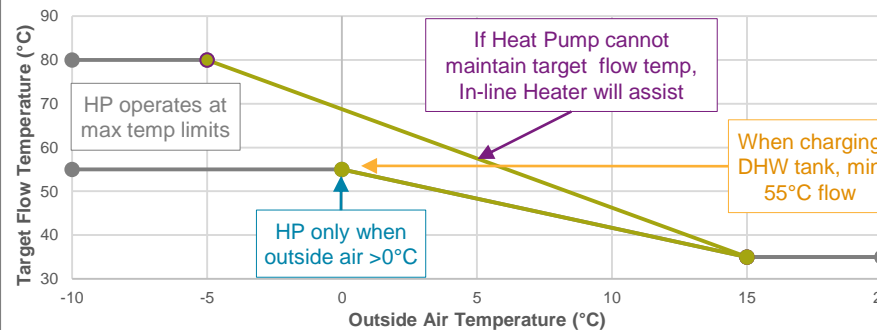

Common Control Logic

Applied to all Heat Pumps Types

- ▶ **DHW Charging:** Minimum Flow Temperature of 55° C
- ▶ **Optimised Start:** Building Pre-heating time between 0 & 90 minutes, calculated morning & afternoon based on outside air temp
- ▶ **Space Heating Schedules:** Defined for weekdays & weekend
- ▶ **Space Heating Set-points:** Defined per room, with Comfort 18° C or 21° C and Set-back = 14° C or 16° C
- ▶ **DHW Tank Set-point:** 55° C, with 5° C deadband (to limit cycling)

Annex D: System configurations simulated in the Building Physics model: Hybrid Heat Pump Installations

Heat Pump Capacity
Hybrid Heat Pumps are smaller than all-electric alternatives

5kW or 8kW Heat Output

0% to 100% Modulation Range

Boiler Capacity
Based on existing boiler capacity

12kW to 18kW Heat Output

25% to 100% Modulation Range

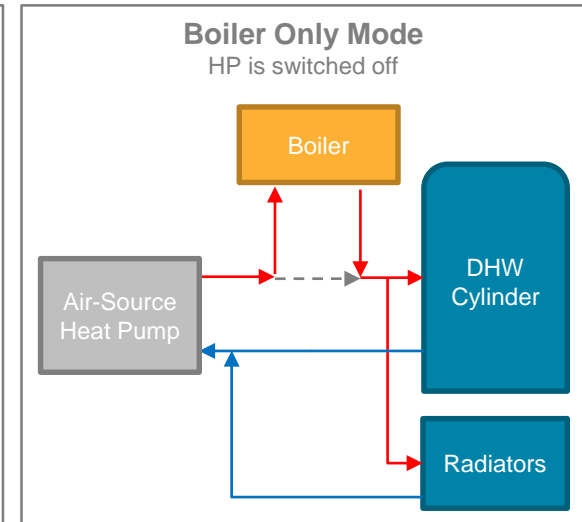
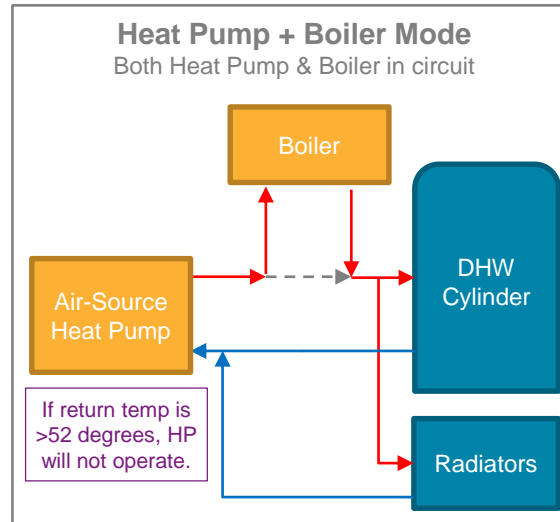
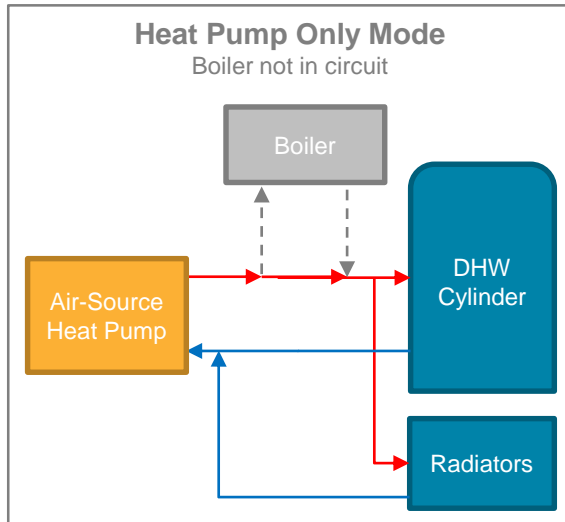

Selecting Operating Mode

Hybrid Heat Pumps

Mode	Outside Temperature
Heat Pump Only	>8°C
Heat Pump + Boiler	-5°C to 8°C
Boiler Only	< -5°C

Boiler operates only when Heat Pump cannot maintain Target Flow Temperature

Heat Pump restricted to limit inefficient operation in very cold weather

Weather Compensation

Hybrid Heat Pumps require 2 levels of control

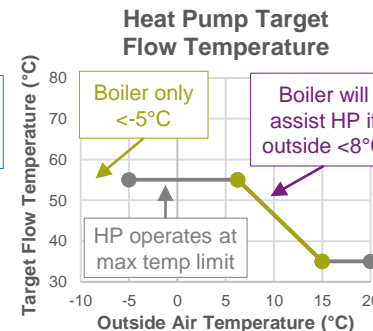
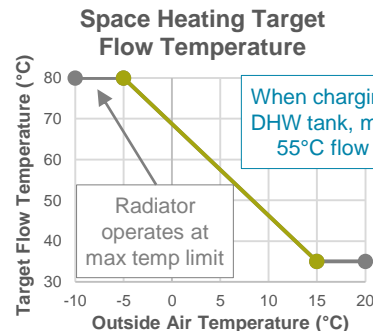

Common Control Logic

Applied to all Heat Pumps Types

- ▶ **DHW Charging:** Minimum Flow Temperature of 55° C
- ▶ **Optimised Start:** Building Pre-heating time between 0 & 90 minutes, calculated morning & afternoon based on outside air temp
- ▶ **Space Heating Schedules:** Defined for weekdays & weekend
- ▶ **Space Heating Set-points:** Defined per room, with Comfort 18° C or 21° C and Set-back = 14° C or 16° C
- ▶ **DHW Tank Set-point:** 55° C, with 5° C deadband (to limit cycling)

Annex E: Example building physics modelling outputs – heat pump load profiles on ‘average’ winter days & ‘1 in 20’ winter days.

Load profile for a higher temperature ASHP in a semi detached dwelling over 2 days in an ‘average’ winter

‘Average’ peak

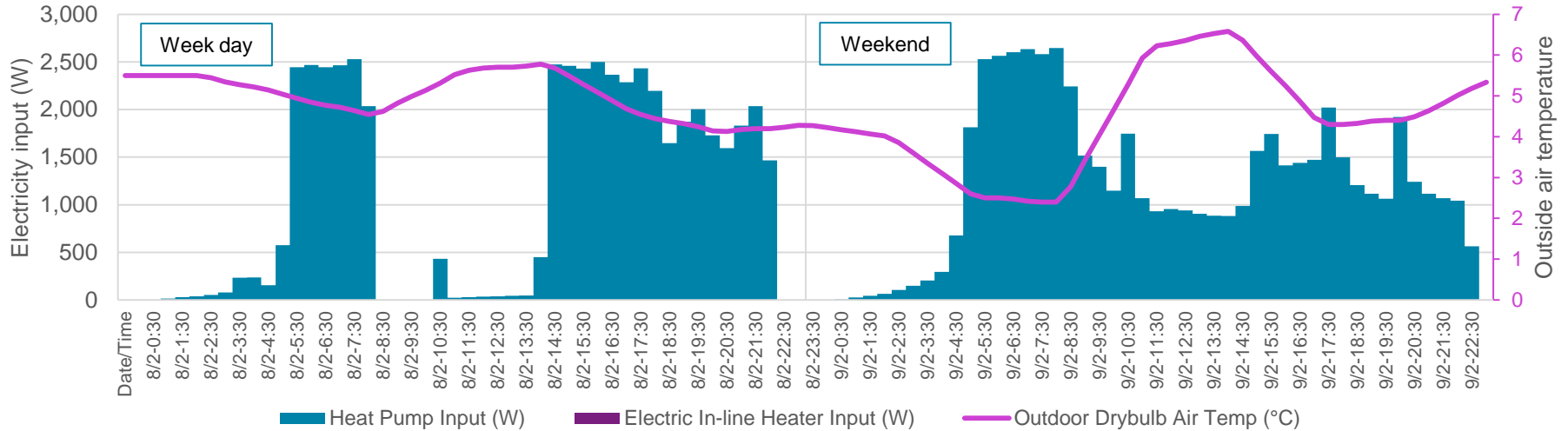

Load profile for a higher temperature ASHP in a semi detached dwelling over 2 days in an ‘average’ winter

‘1 in 20’ peak

