



Electricity Specification 353

Issue 1

December 2017

Integral Distribution Substations

Contents

- 1 Scope
 - 2 Definitions
 - 3 Requirements for Integral Distribution Substations
 - 4 Documents Referenced
 - 5 Keywords
- Appendix A Basement Substations

**Approved for issue by the
Technical Policy Panel**

© 2017 Electricity North West Limited.

All Rights Reserved

The copyright of this document, which contains information of a proprietary nature, is vested in Electricity North West Limited. The contents of this document may not be used for purposes other than that for which it has been supplied and may not be reproduced, either wholly or in part, in any way whatsoever. It may not be used by, or its contents divulged to, any other person whatsoever without the prior written permission of Electricity North West Limited.

Issue and Amendment Summary

Amendment No. Date	Brief Description and Amending Action
<p>0 08/12/17</p>	<p>Issue 1</p> <p>First Issue</p> <p>Prepared by: M A Kayes</p> <p>Approved by the Technical Policy Panel and signed on its behalf by: Steve Cox, Engineering and Technical Director</p>

INTEGRAL DISTRIBUTION SUBSTATIONS

1. SCOPE

This document specifies the requirements for the design and construction of Integral Distribution Substations that are to become part of the electricity distribution network owned and operated by Electricity North West Limited (hereinafter known as Electricity North West).

2. DEFINITIONS

Integral Distribution Substation: A substation where switching and/or transformation is carried out at a voltage not exceeding 11kV and which is housed within a larger building not owned by Electricity North West (e.g. a substation within an office block).

3. REQUIREMENTS FOR INTEGRAL DISTRIBUTION SUBSTATIONS

Integral Distribution Substations shall comply generally with the requirements for a Standard Indoor Substation or Indoor Distribution Substation equipped with Primary Substation style equipment as stated in ES352 together with the following specific requirements.

3.1 Location

Substations shall normally be located at ground level with direct external access. Locations above ground level are not acceptable under any circumstances. Substations may be located below ground level (for example in a multi-storey shopping centre service area) providing full access is always available (see 3.2) and providing consideration is given to the risk of flooding.

At least one wall of the substation shall face outwards from the building to facilitate external access and cable entry.

Substations located in basements will only be considered in very limited circumstances where no other options exist. See Appendix A for further details.

3.2 Personnel and Vehicle Access

24-hour access for both personnel and vehicles is required. Wherever possible, access shall be from public highway land (e.g. roads and car parks). Substations shall only be located within a private secured perimeter if either a dual locked perimeter access gates or a 24-hour manned security gate is provided. The access route shall be suitable for a plant delivery HIAB vehicle of gross weight 32 tonnes with a minimum ceiling height of 6 metres.

Where access is from a car park area or non-public road that abuts the substation building, the area immediately in front of the substation doors must always be kept clear. This shall be achieved by marking the car park / road surface with yellow hatching 3m in depth for the width of the substation and by fixing appropriate “no parking” signs to the building walls either side of the substation doors.

3.3 Dimensions

Minimum internal dimensions shall be in accordance with ES352. Account shall be taken of the need to provide sufficient volume for internal arc venting if the design of the switchgear so requires (see 3.7).

3.4 Doors

Doors shall not open directly onto a highway and shall normally be capable of being opened through 180° and secured in that position.

Roller shutter doors are not acceptable.

3.5 Ventilation and Environmental Control

Natural ventilation shall normally be provided in accordance with ES352.

Where the high voltage switchgear is of a type normally installed in a primary substation, environmental control by means of restricted ventilation and air conditioning to provide appropriate temperature and humidity levels shall be provided in accordance with CP351.

3.6 Floor

The strength of the floor shall be such as to safely accommodate the weight of the installed items of plant (e.g. switchgear and transformers). The weights of equipment are available from Electricity North West on request.

3.7 Fire Protection and Explosion Containment

The risk of fire is very low even with oil filled equipment. Modern oil filled switchgear properly maintained is most unlikely to fail disruptively. Even if it does so, the oil quantity is small. A distribution transformer with adequate protection has not been known to cause fire but can, nevertheless, be a source of fuel to an external fire.

The developer shall consider the effects of a fire within the substation upon the building and its occupants. The substation building walls, roof, floor, all ducts, cable sealants and doors shall be constructed to suit the requirements of Building Regulations 2010 Part B, Fire Safety. The substation must undergo a Fire Risk Assessment in accordance with EPD 357, Fire Risk Assessments for Operational Sites. The Fire Risk Assessment shall comply with EPD 357, Fire Risk Assessments for Operational Sites. The effects of smoke emanating from ventilation louvres shall also be considered. If all the risk assessment conditions can be met and there is no restriction on the type of plant, ie oil filled transformers and switchgear may be used. Where these requirements cannot be fully met, the use of oil free and compound free equipment or installation of an automatic fire control/extinguishing system, shall be considered (see below).

Fire alarms and fixed fire-fighting equipment are not normally fitted within substations. Should the developer, local Building Control department or the Fire Authority require their provision, then they will be liable for all inspection and maintenance thereof. They should be aware that access for such purposes will have to be arranged in advance and Electricity North West may charge for providing this service. If a fixed fire extinguishing system is required, reference shall be made to current legislation and to the Electricity North West Civil Policy Manager in order to ascertain the correct extinguishing medium to be used.

Special precautions may also be necessary in other high-risk fire zones e.g. substations in industrial premises subject to the Fire Certificates (Special Premises) Regulations 1976, i.e. those requiring a fire certificate from the Health and Safety Executive - being premises where highly flammable or dangerous substances are processed or stored in bulk. Whenever possible, substations shall be sited outside the high-risk area itself.

It is also essential that the use to which the premises is to be put is known and any requirements for compliance with special regulations associated with the activities are understood.

The substation building shall be designed to withstand the effects of an internal arc occurring within the switchgear. Such an arc gives rise to a pressure wave. Venting the arc into a sufficient volume of air in the substation normally provides sufficient explosion relief. Advice should be sought at an early stage of the design to ensure that this requirement is met.

All High Voltage and Low Voltage Cables shall be Low Smoke Zero Halogen (LSOH).

3.8 Noise and Vibration

The architect shall take account of the effect of the likely levels of noise and vibration from any transformer housed within the substation on the building's occupants. Appropriate mitigating measures shall be applied to the design and construction of the building to minimise these effects. The sound power levels are available from Electricity North West on request. The maximum sound power level (dB(A)) is currently 59dB(A).

3.9 Joint Access

Where joint access arrangements to the substation are required, these shall be in accordance with CP258.

3.10 Cable Management

Suitable ducts shall be provided for cables entering the substation from below ground level outside.

Suitable slots/trenches shall be provided within the substation floor to enable connections to the installed plant within the building.

Suitable cable entries shall be provided for cables running from the substation into the remainder of the building.

Where cables are run in voids, corridors or basements etc, suitable supports such as traywork shall be provided, the cables and traywork shall be protected against unauthorised access by fully containing them with suitable danger of death signage added to the containment. A secure (eg lockable with Electricity North West Padlocks) means of access to such voids for authorised persons shall always be provided.

All High Voltage and Low Voltage Cables shall be Low Smoke Zero Halogen (LSOH).

3.11 Low Voltage Supplies

The substation low voltage supply shall normally be provided in accordance with ES397. Where this is not practicable, then the supply shall be provided from the building wiring installation. Electricity North West would not expect such a supply to be metered nor to pay any charges in respect of energy used.

3.12 Maintenance

Maintenance of the building, doors, etc, is the responsibility of the building owner.

3.13 Wayleaves

No Integral Substation or Switching Station shall be commissioned until ALL wayleaves have been fully signed up.

4. DOCUMENTS REFERENCED

BS EN 771-1:	Specification for masonry units. Clay masonry units
EPD357	Fire Risk Assessments for Operational Sites
EPD603:	Substation Locking
CP258:	Connections for Industrial and Commercial Customers
CP351:	Civil Design Aspects of Primary Substations
ES352:	Design of Distribution Substations and Transforming Points
ES397:	Electrical Installations within Distribution Substations
ES400D5	Duct Seal

5. KEYWORDS

Design, Substation

APPENDIX A

BASEMENT SUBSTATIONS

A1 General

Basement substations will only be accepted in a very limited range of circumstances:

- Where the substation is to be located in a listed building, planning restrictions preclude ground-level substation access and adaptation of the building to enable a ground-level substation is not practicable.
- Where the developer cannot obtain any ground-level space.

Acceptance of any new basement substation shall be subject to the approval of Electricity North West Policy and Standards Manager.

A2 Access

24-hour direct access from public highway land shall be available for Electricity North West operational staff.

A3 Fire Resistance

The fire resistance shall be subject to the information detailed in section 3.7. The building owner shall establish the minimum fire resistance is required for basement substations. This shall meet the requirements of a Fire risk assessment for the building the substation is within. The Fire Risk Assessment shall comply with EPD 357, Fire Risk Assessments for Operational Sites.

A4 Plant Access

Plant access shall be by means of a hatch within the building ground floor slab. The hatch shall provide a minimum clear opening of 2000x1500mm when the covers are removed. A permanent lifting beam and trolley of 5000kg SWL shall be provided above the hatch to enable plant to be lowered to basement level. A removable brickwork opening from basement level into the substation enclosure shall be provided.

The plant access hatch shall not be impeded by any service; cables, ducts or pipes, and by any permanent objects or structures. This also includes the area between the hatch and the lifting beam.

A5 Typical Arrangement

The requirements for a basement substation are shown in Drawing I-353-GA-001 and the notes following the drawing.

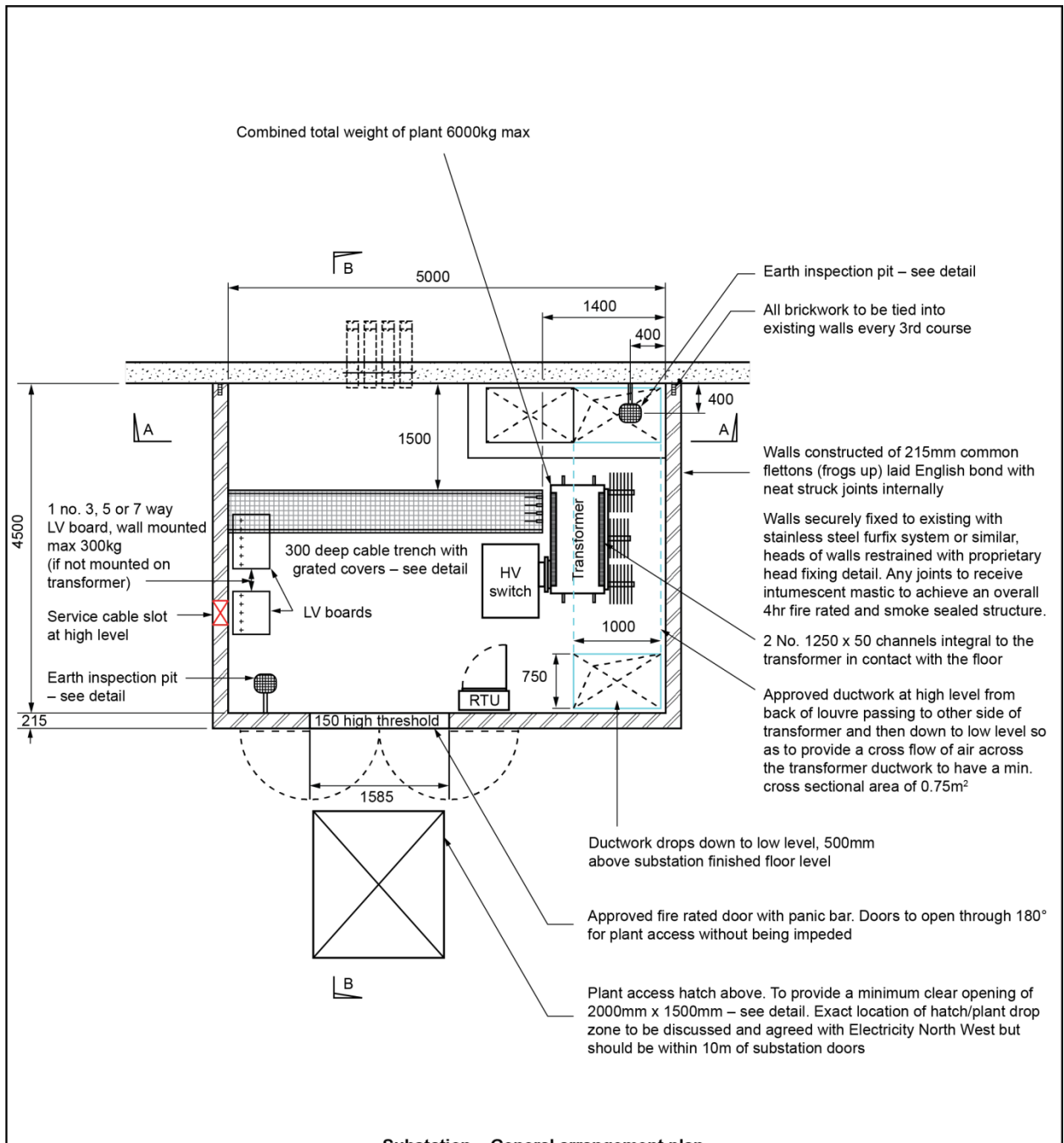

Substation - General arrangement plan

BASEMENT SUBSTATION	Change information for this issue N/A	Appears in ES353	Electricity north west
			I-353-GA-001 Iss 1 sht 1 of 4 Scale: nts Auth: MAK Date: 8/12/2017

Typical alternative detail for basements with drained cavity

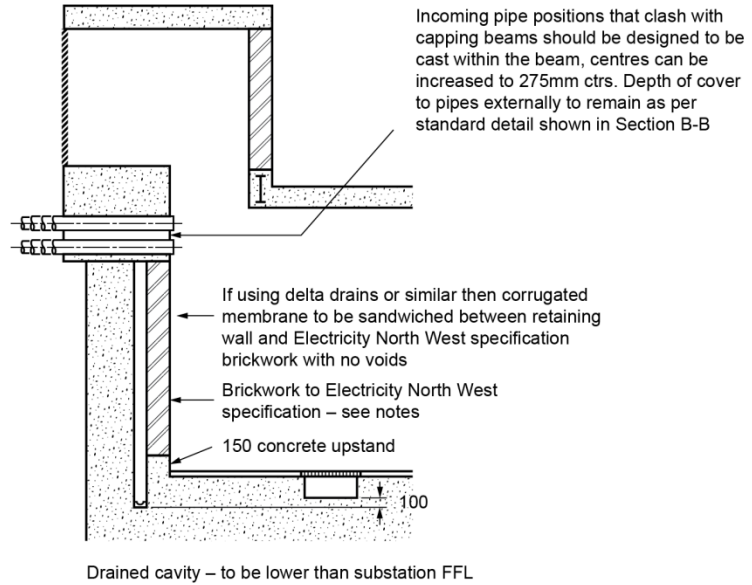

Cable trench grating detail

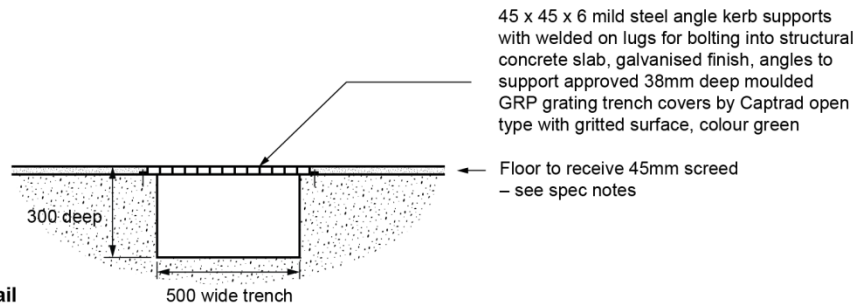

Earthing detail

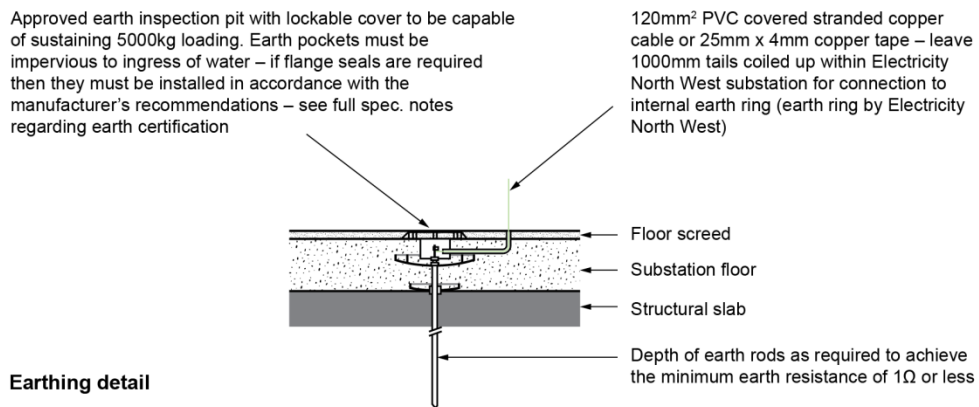

BASEMENT SUBSTATION

Change information for this issue
N/A

Appears in
ES353

Electricity
north west

I-353-GA-001 Iss 1 sht 2 of 4

Scale: nts Auth: MAK Date: 8/12/2017

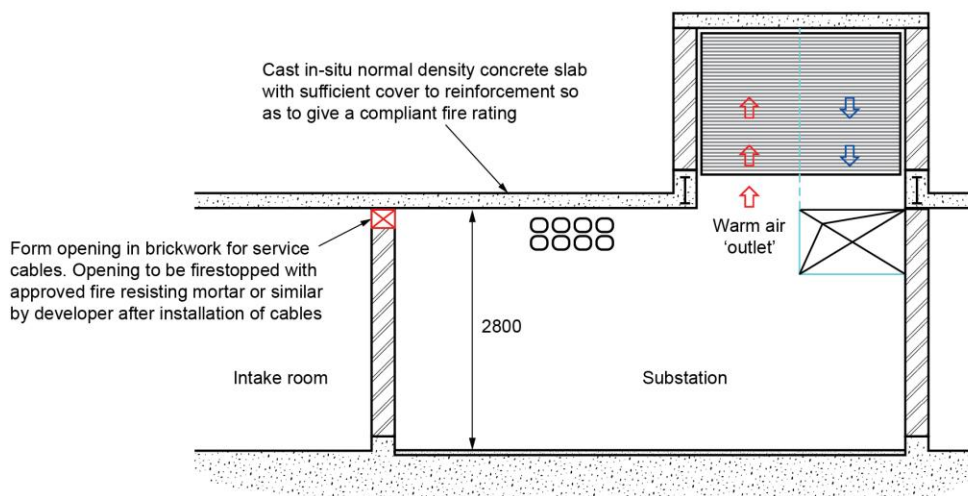

Section A-A

BASEMENT SUBSTATION

Change information for this issue
N/A

Appears in
ES353

Electricity
north west

I-353-GA-001 Iss 1 sht 3 of 4

Scale: nts Auth: MAK Date: 8/12/2017

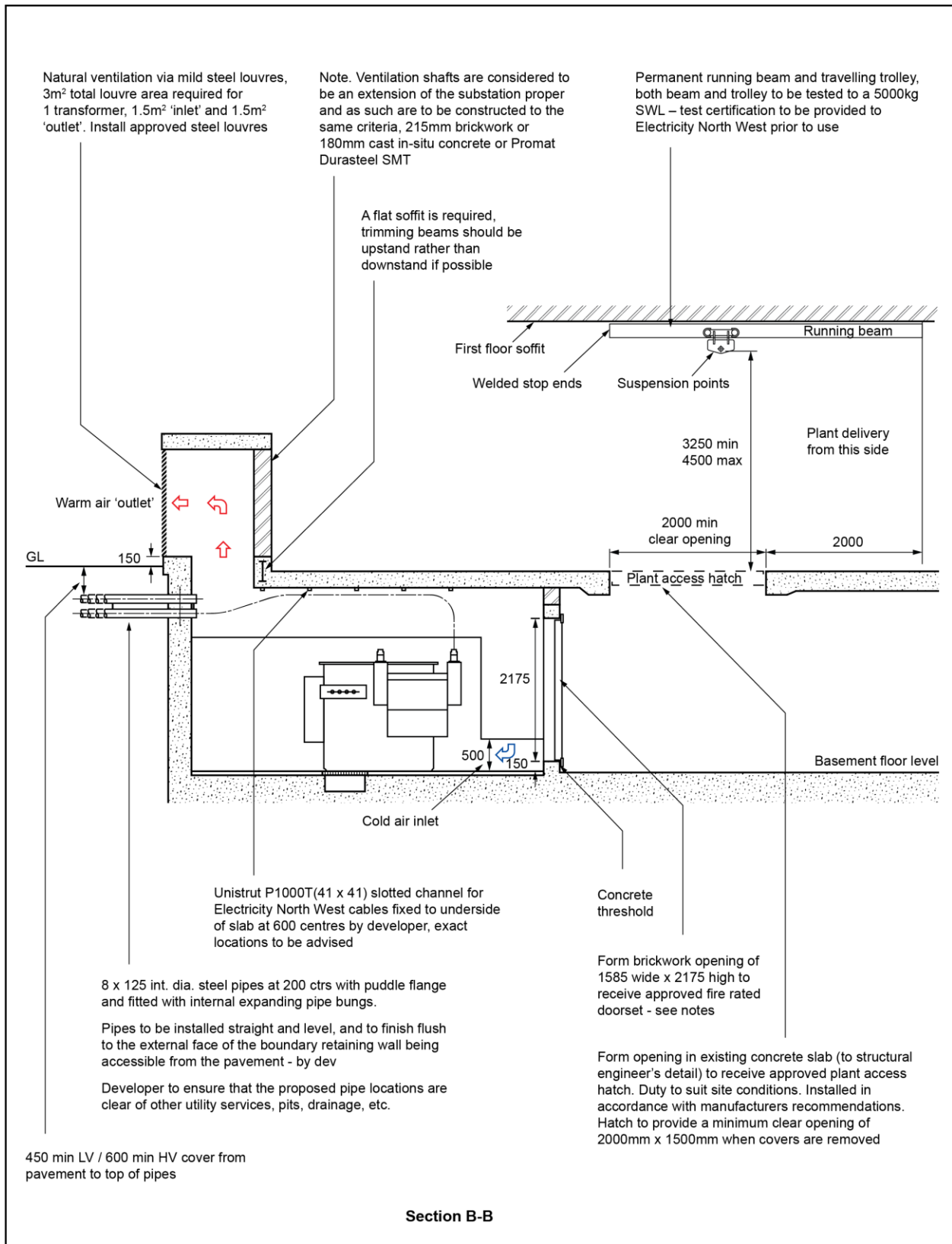

BASEMENT SUBSTATION	Change information for this issue N/A	Appears in ES353	
			I-353-GA-001 Iss 1 sht 4 of 4 Scale: nts Auth: MAK Date: 8/12/2017

Notes on Drawing I-353-GA-001

All builders' work to be provided by client's developer/builder unless expressly stated otherwise.

General notes:

- This drawing is not to be scaled and no variation to the stated dimensions or materials specification will be permitted without prior written consent from Electricity North West.
- All dimensions are in millimetres.
- The running of heating, gas, telecoms, water and other services through or under the substation area will not be permitted. All existing services to be diverted clear or removed from the substation area.
- The developer will be responsible for obtaining all planning consents and building regulation approvals before construction work commences.

Substation location:

- It is important that the position and orientation of the substation is discussed and agreed with the Electricity North West project designer prior to the commencement of any building works on site.
- Basement substations should be located on the perimeter of the site on the first available level below external ground.
- 24-hour unimpeded Electricity North West personnel access is required via a dedicated staircase.
- Doors on the access route are to be locked in the standard Electricity North West locking suite.
- Access via 24-hour security or a third party is unacceptable.

Concrete and reinforcement:

- The fire resistance of the concrete shall be subject to the information detailed in section 3.7. The building owner shall establish the minimum fire resistance is required for basement substations. Nominally a minimum 4 hour fire resistance rating should be considered.

Floor slab:

- Cast in-situ reinforced concrete slab to client's structural engineer's detail to support a load of 4500kg in any position. The transformer sits on 2 integral steel channels approx 1250 long x 50 wide at 550 centres, see plan for locations. The floor of the substation and throughout the whole of the plant access to be capable of sustaining this load.
- 150 concrete upstands to base of all walls to act as an oil bund.

- Top of slab to be screeded with a high performance floor screed or topping finished with a surface hardener so as to provide both impact and abrasion resistance. A minimum compressive strength of 45N/mm² (after 28 days) is required.
- All concrete works to be finished smooth and level within ±2mm over and 2000mm dimension – it should be noted that a high standard of workmanship is required.
- Kerb angles for trench grating to be bolted into structural slab and the floor screed / topping must be laid flush with the substation finished floor level. There must be no trip hazards.

Roof slab:

- 150mm min. cast in-situ reinforced concrete with sufficient minimum cover to reinforcement so as to provide the correct fire rating for the building as detailed in the risk assessment and section 3.7. Nominally a minimum 4 hour rating should be considered.
- Reinforcement to client's structural engineer's detail.
- Hollow pot beams, precast planks or lightweight concrete on profiled metal decking are not permitted.

Walls:

- To be constructed of 215 fully bonded brickwork to BS EN 771-1 laid English bond, bricks to be frogged and have a minimum compressive strength of >20N/mm² (durability min) with neat struck joints, walls to provide flush finish internally.

Cast in-situ reinforced concrete walls to have sufficient minimum cover to reinforcement so as to provide the correct fire rating for the building as detailed in the risk assessment and section 3.7 and provide a smooth finish internally. Nominally a minimum 4 hour rating should be considered.

Doors:

- Approved fire rated doorset to provide the correct fire rating for the building as detailed in the risk assessment and section 3.7. Nominally a minimum 4 hour rating should be considered.
- Active leaf to be fitted with panic bar and approved emergency escape hardware secured externally by locking to EPD 603.
- Intumescent mastic pointing to frame surrounds internally and externally in accordance with door manufacturer's recommendations.
- Fire rated doors must be used with in conjunction with an equivalent fire rated lintel, use King Stone Super Fine range – type 29 (215 x 215) or equivalent.
- Note that steel lintels or multiple precast units are not permitted.

Ventilation:

- Naturally ventilated via louvres at ground level – see drawing.
- Cold air 'inlet' ducted down to low level to promote good 'stack effect'.

- Louvres must vent into free air and not enclosed spaces or areas where heat or smoke dissipation from the substation below would compromise adjoining escape routes.
- Louvres to be of approved steel construction.
- Mastic pointing to frame surrounds externally.

Cable entries:

- The exact number of steel pipes to be installed will be clarified by Electricity North West to suit the project – 8 pipe entries is typical.
- Pipes to be installed through retaining wall, top row of pipes to have 450mm / 600 max cover from pavement level.
- Permitted pipes – 125mm int. dia. welded steel tube with no protruding seam internally or seamless, medium duty, self colour finish. Internal weld must be smooth to the touch.
- Pipe entries to be puddle flanged and cast within the retaining wall.
- Developer to ensure that proposed cable pipe positions are accessible and clear of any other passing obstructions, utility services, drainage, pits, etc.
- All cable entries to be sealed on the inside inline with Electricity North West Policy Document ES400D5.

Finishes:

- Floor to receive 2 coats of grey concrete floor paint.
- Walls and ceiling to receive 2 coats of white emulsion for dust sealing.
- Louvres to be powder coated, colour to harmonise with adjacent surroundings.
- Doors to receive 2 coats of protective gloss paint colour grey.

Earthing:

Earthing to be in accordance with the principles in ES352 and CP333 but will need to be assessed against the site specific requirements. Full details shall be submitted to the Electricity North West Protection Policy Manager for approval.

The guidance in principle is as follows:-

- 2 No. earth rods to be supplied, installed and tested by developer's contractor – see plans for locations. Earth rods installed for Electricity North West use should not under any circumstances be interconnected with any earth system for lighting protection nor should earth electrodes used for that system be installed under or in close proximity to the substation. A reading of 1 Ω or less should be achieved for each earth rod. Total correct reading to be provided to Electricity North West for their records.
- Leave 1000mm tails within substation for connection to earth ring.

Cables:

- All High Voltage and Low Voltage Cables shall be of Low Smoke Zero Halogen (LSOH).

Notes for Electricity North West Contractors

Plant Installation:

- Site survey required prior to plant delivery to determine site conditions.

Earthing:

- Connect earth tails to common earth bar – earth ring by Electricity North West.